

223

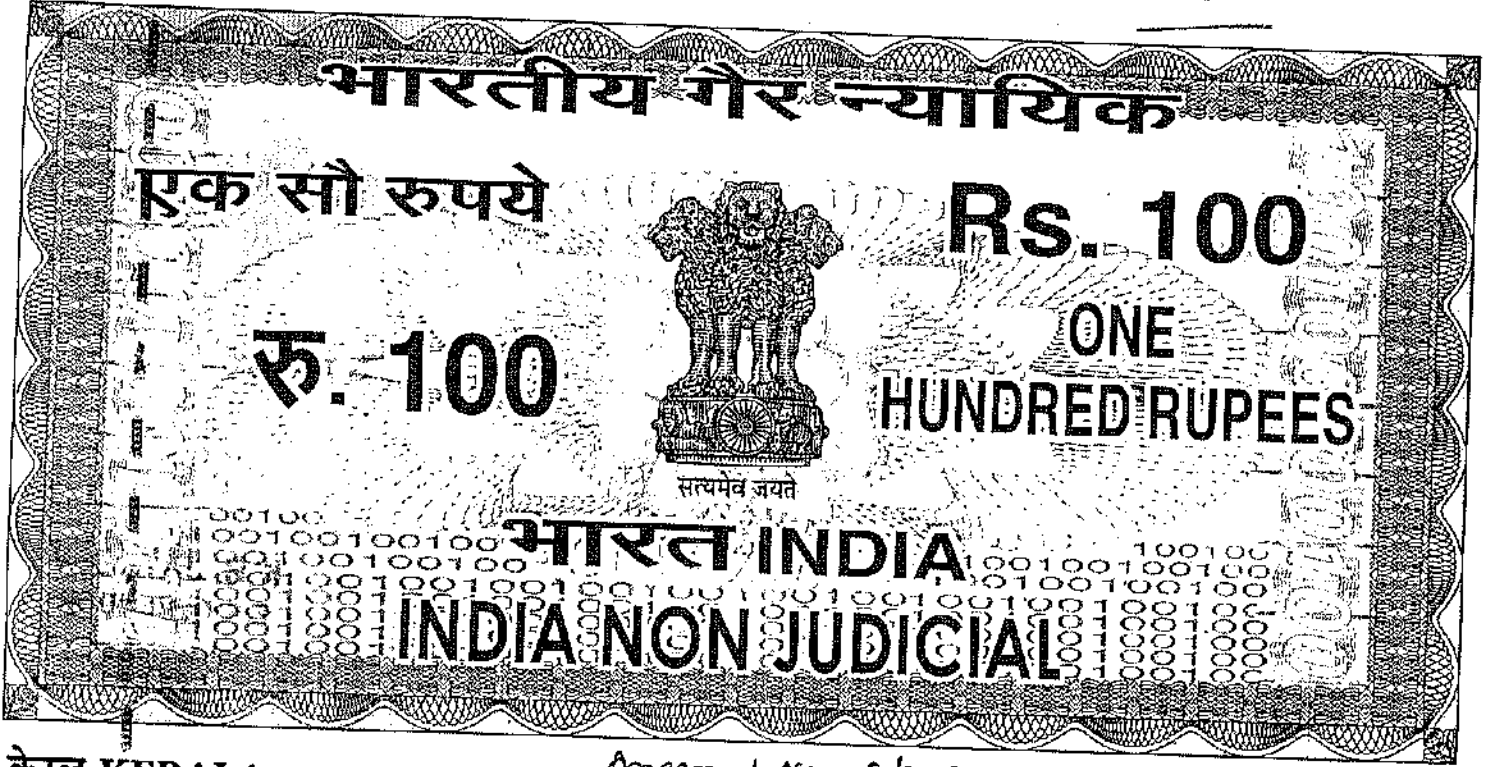

केरल KERALA

Agreement No: 2/2008-09  
23 April

B 578321

This Agreement entered into on this 23 day of March, 2008 at Thiruvanthapuram

BETWEEN

Kerala State Electricity Board (hereinafter referred to as "Buyer" which expression shall, unless repugnant to the subject or context include its successors, legal heirs and /or assignees as well) of the ONE PART,

AND

M/s. Asian Star Company Limited, a Company registered under the Companies Act 1956 having its registered office at 114-C, Mittal Court, Nariman Point, Mumbai - 400 021 (hereinafter referred to as the "Company" which expression shall when the context so admits or implies be deemed to include its successors, legal heirs and/or assignees as well) of the OTHER PART.

*[Signature]*  
**CHIEF ENGINEER**  
 (Corporate Planning)  
 KSE Board, Vidyuthi Bhavanam  
 Pattom, Thiruvananthapuram - 4

*[Signature]*  
**DIRECTOR**

Contd ..... 2

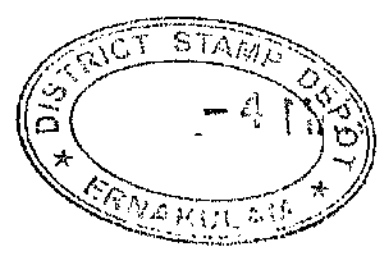

**WHEREAS:**

1. In pursuance of the Government of Kerala policy regarding promotion of power generation from non-conventional sources within Kerala, Government has proposed to encourage and facilitate the development of wind projects as captive and independent power projects in Private land to exploit the wind potential and develop low cost generation sources within the State;
2. Government of Kerala vide its order No. G.O (MS) 23/2004/PD dated 06<sup>th</sup> November 2004 and the revised G.O vide its order No. G.O (MS) 7/2007/PD dated 11.5.2007 has notified the guidelines for allowing private sector participation in Wind generation in Private Land.
3. Hon'ble Kerala State Electricity Regulatory Commission has notified regulation No 1/1/KSERC - 2006/XV namely, KSERC (Power Procurement from Renewable Sources by distribution licensees) Regulations, 2006 on 24<sup>th</sup> June 2006 in accordance with provisions of clause (e) of Sub-section (1) of Section 86 of Electricity Act, 2003. As per clause 31 of the regulation the Board (deemed distribution licensee) is required to procure at least 2% of the electricity from Wind Energy sources with effect from 1<sup>st</sup> April 2006.
4. As per the revised G.O. cited, it is required to apply for Technical clearance from the Nodal Agency ANERT and interconnection permission from KSE Board. Vide proceedings A.O. No.1258 / WPC/ ANERT / 07 dated 01.12.2007 of Director, ANERT technical approval has been accorded to **M/s. Sarjan Realities Ltd.** for installation of one no 600 Kw wind electric generators at 524 (Part) area in Kottathara Village of Mannarkkad Taluk, Palakkad District, and the same has been transferred to **M/s. Asian Star Company Ltd. vide proceeding A.O. No.329 /WPC/ ANERT/ 08 dated 29.03.08** Vide letter no: *CE/ TRN/ES/Agaki-wind mill/08-09 dtd 28.5.08* of Chief Engineer, Transmission North, KSE Board, interconnection permission has been accorded to the Company.
5. The company is desirous of selling the entire power produced from the Wind Mill Of Capacity 600KW located at **524 (part)** survey no, Mannarkkad Taluk, Palakkad District, Kerala State and the buyer is now desirous of purchasing The entire power generated from the proposed project.

**NOW, IT IS MUTALLY AGREED BY AND BETWEEN THE PARTIES AS FOLLOWS.**

**ARTICLE 1****DEFINITIONS AND INTERPRETATIONS****1.1 Definitions**

Wherever the following terms appear in this Agreement, whether in the singular or in the plural, present or past tense, they shall have the meaning stated below, unless repugnant to the context:

- (a) "**Accounting Year**" the financial year commencing from 1<sup>st</sup> April of a calendar year and ending on 31<sup>st</sup> March of the next calendar year.

  
**CHIEF ENGINEER**  
 (Regional Office)  
 KSEB District Office, Mannarkkad  
 Palakkad District, Palakkad - 4

**For ASIAN STAR CO LTD**

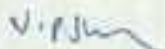
  
**DIRECTOR**

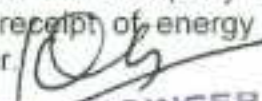

- (b) **"Agreement"** means this Agreement including all Schedules and Annexures, together with any amendment thereto as may be made by mutual consent of the parties in writing herein after referred to as 'PPA'
- (c) **"ANERT"** means the Agency for Non-Conventional Energy and Rural Technology.
- (d) **"Applicable Laws"** means the existing and future laws enacted by the Parliament or Kerala State Legislature which are in force for the time being including ordinances regulations and rules made there under, and judgments, decrees, or orders of any court, and international treaties and conventions having force of law during the subsistence of this Agreement.
- (e) **"Authorized Agency"** means an agency duly authorized by Government for the purpose.
- (f) **"Auxiliary Consumption"** means the internal consumption of power by the company, which shall be the difference between the number of units (Kwh) generated by the Project as measured at the generator terminals at each generator unit and the number of units (kwh) as measured at the interconnection point including transformation losses.
- (g) **"Billing Date"** means the 5<sup>th</sup> day after the Metering Date or the next business day of the buyer.
- (h) **"Billing year"** means the period beginning on the Commercial Operation Date and ending at 12.00 midnight of the following March 31<sup>st</sup>. Thereafter each successive billing year shall begin on April 1<sup>st</sup> and end on March 31<sup>st</sup> of the following year, except that the final billing year shall end on the date of expiry of the term or on termination of this Agreement, whichever is earlier.
- (i) **"Business Day"** means a day on which the commercial bank and Buyer are open for business in Thiruvanthapuram
- (j) **"Buyer's Supply Regulations "** means the regulations notified by Kerala State Electricity Regulatory Commission from time to time with regard to supply of electricity.
- (k) **"Change in Law"** means the occurrence or coming into force of any of the following:
- (i) the enactment of any law or legislation passed by the State Legislature; or Parliament
  - (ii) the repeal, modification or re-enactment of any existing Indian law: Provided that change in law shall not include:
  - (iii) coming into effect after the date of signing this Agreement of any provision of a statute which is already in place as of the date of signing this Agreement; or
  - (iv) any new law or any change in existing law under the active consideration of or in the contemplation of any Agreement as on the date of signing of Agreement, which is a matter of public knowledge.
- (l) **"Check Meter"** means any meter and/or metering device of accuracy class equivalent to the Main Meter installed and maintained by the Buyer at the cost of the Company at the interconnecting point to measure the delivery and receipt of energy and power for the purpose of checking the Main Meter.

  
**CHIEF ENGINEER**  
 (Corporate Printing)  
 Madhav Varma, Thiruvananthapuram

For ASIAN STAR CO. LTD.,

  
 J.P.M.  
 Director

Contd ..... 4

- (m) **“Clearances”** shall mean the clearances as mentioned in Schedule 6 .
- (n) **“Commercial Operation Date (COD)”** with respect to each **individual** generating unit, means the date on which such generating unit makes entry into commercial service and with respect to the Project the date on which the Project makes commercial operation pursuant to the Performance Tests demonstrated by the Company before Buyer and the authorised agency pursuant to Article 5 and in any case shall not be beyond the scheduled date of completion.
- (o) **“Commission”** means Kerala State Electricity Regulatory Commission.
- (p) **“Company”** means a company formed and registered under the Companies Act 1956 (1 of 1956) and includes any body corporate under a Central, State or Provincial Act.
- (q) **“Computer Monitoring System”(CMS)** means the computer based monitoring System comprised of hardware, software, and private communication system extending to each wind turbine, which system gathers, archives and reports turbine operating data.
- (r) **“Cut-in Wind Speed”** means the minimum wind speed at which the Wind Electric Generators is deliverable to a load.
- (s) **“Cut-out Wind speed”** means the maximum wind speed at which the Wind Electric Generators produces energy.
- (t) **“Day”** shall mean 24 (twenty four) hour's period beginning at 0.00 Hrs Indian Standard Time and ending at 24.00 Hrs on the same day.
- (u) **“Delivered Energy”** means the total energy delivered and metered at the **Interconnection point**.
- (v) **“Design Energy”** means the energy to be generated by the Project in a year as detailed in the Wind mapping study contained in the Micro survey(sitting) Report.
- (w) **“Despatch Instructions”** means the instruction from the State Load Despatch Centre to schedule and control the generation at the Project in order to commence, increase, decrease or cease the energy delivered to the Buyer/STU's grid system.
- (x) **“Dispute”**: means any dispute, difference or controversy between the Parties arising under or out of, or in relation to, this Agreement and so Notified in writing by any party to other party.
- (y) **“Due date of Payment”** means the 10<sup>th</sup> day after the billing date.
- (z) **“Electricity Act 2003”** or **Act 2003** means Electricity Act 2003 as amended from time to time.

  
**CHIEF ENGINEER**  
 (Corporate Planning)  
 KSEB zone, Vidyut Bhavanam  
 Pallom, Thiruvananthapuram - 4

For ASIAN STAR CO. LTD.,

  
**DIRECTOR**



- (aa) **"Evacuation System"** means transmission facilities built from the pooling Substation / Wind Electric Generator 's at 33 KV up to Kerala grid system.
- (ab) **"Financial Closure"** means the signing of the Financing Documents for Project financing and the fulfillment of all conditions precedent to the initial availability of funds there under and the receipt of commitments for such Equity as required by the Company to satisfy the requirements of the Lenders, provided however that the Company has immediate access to funds (subject to giving the required draw down notices) regarded as adequate by the Company and on terms regarded as satisfactory by the Company and in any case shall be achieved within 3 months from the date of signing of this Agreement.
- (ac) **"Force Majeure events"** shall have the meaning set forth in Article 14 hereof.
- (ad) **"Government"** means the Government of Kerala.
- (ae) **"Generating Unit"** means one set of wind generator and auxiliary equipment and facilities forming part of the project.
- (af) **"Grid System"** means the Buyer/STU's network of transmission and distribution through which the Delivered Energy is evacuated and distributed.
- (ag) **"Guaranteed Capacity"** with respect to each generating unit, means the generating capacity (net of auxiliary load) of such generating unit and with respect to the project, generating capacity (net of auxiliary unit ) as determined in accordance with article 5.4, guaranteed by the company to Board at the interconnection point, subject to the ceiling of nominal capacity, correction factors such as grid frequency, ambient temperature, humidity, wind speed etc.
- (ah) **"Infirm Energy"** means energy generated prior to the date of Commercial Operation Date of each generating unit and metered at the interconnection Point.
- (ai) **"Interconnection Facilities"** means all facilities installed by the Company to enable the Buyer's Grid System to receive the delivered energy from the Project at the interconnection Point including the transformer and the associated equipments, relay and switching equipments, protective devices and safety equipments and transmission lines from the Project to the nearest interconnecting point.
- (aj) **"Inter connection Point"** means gantry point or points in the nearest buyer/STU's Substation.
- (ak) **"Interconnecting substation"** includes facilities located at the nearest substation of the buyer/STU where the project transmission line connects to the Kerala grid.
- (al) **"Kerala State Electricity Grid code" (KSEGC)** means the State Grid code specified under class ( h ) of subsection ( 1 ) of section 86 of the Electricity Act 2003 by Kerala State Electricity Regulatory Commission and as amended from time to time.
- (am) **"Lender"** means the financial Institution, bank, fund or trust who provide or refinance the debt component of the cost of the project ( including guarantee, letter of credit, risk participation facility, take out facility and other forms of credit enhancement) and includes subscribers to / trustee for the holders of the debentures / bonds other securities issued by the developer to meet the cost of the project.

- (an) **“Material Adverse Effect”** means a material adverse effect on the ability of Company to exercise any of its rights or perform/discharge any of its Duties/obligations under and in accordance with the provisions of this Agreement.
- (ao) **“Main Meter”** means the Availability Based Tariff compatible special energy meter of 0.2 class accuracy having import / export registering facility and applicable IEC / BIS standards as per Central Electricity Authority ( Installation and Operation of Meters ) regulations 2006 with its amendments thereupon to record the delivery and receipt of energy at the inter connection point.
- (ap) **“Maintenance Outage”** means an interruption or reduction of the generating capability of the Project for purpose of performing work on specific components which work should not in the reasonable opinion of the company be postponed until the next Scheduled Outage and shall be scheduled and allowed by the Buyer/State Transmission Utility.
- (aq) **“Meters”** shall mean a Main Meter and a Check Meter.
- (ar) **“Metering Date”** for a billing period means the first working day of each calendar month for a scheduled time mutually agreed between the parties.
- (as) **“Metering Code”** means the Regulations notified by Central Electricity Authority as per 'Installations and Operations of meters, Regulations 2006.
- (at) **“Metering Point”** means the point located at the interconnection point at which the energy delivered is metered.
- (au) **“MVAR”** means Megavars
- (av) **“MW”** means Megawatts
- (aw) **“MWh”** means Megawatt hour.
- (ax) **“National Electricity Policy”** means Policy notified by the Central Government in compliance with section 3 of Act 2003.
- (ay) **“Nominal Capacity”** with respect to a generating unit means the net generating unit capacity of 0.60 MW, at 0.95 pf lag at the interconnection point and with respect to the Project the net generating capacity of 0.60 MW at 0.95 pf lag at the interconnection Point under the Project Site condition and frequency variation between 48.5 Hz and 51.00 Hz (at 40°C and at 80% relative humidity) as furnished by the manufacturer/supplier in the purchase contract with the Company and after deduction of auxiliary consumption.
- (az) **“Operating period”** means the period commencing from COD and ending at the expiry of the term of the agreement specified in this PPA.
- (aaa) **“Party”** means a party to this agreement.
- (aab) **“Performance Tests”** shall mean the tests specified in Article 5.
- (aac) **“Pooling substation”** means facilities developed by KSEB/developer so as to pool the wind power in each potential area.

  
**CHIEF ENGINEER**  
 (Corporate Planning)  
 KSE Board, Vyttila, Shivanam

For ASIAN STAR CO. LTD.,

  
**DIRECTOR**

Contd ..... 7

- (aad) **"Project"** means the wind power project set up at 524 (Part) survey no. Mannarkkad Taluk, Palakkad District, Kerala State, comprising of 600 KW Capacity, one no of Wind Turbines as described in schedule 9, ancillary equipment and facilities suitable for generating nominal capacity and includes all Civil & Electrical works, Central Monitoring & Control system, overhead transmission/sub transmission line up to interconnection point/pooling substation, land, buildings (including staff quarters) and infrastructure and other facilities, ancillary and related establishments, equipments and conveniences.
- (aae) **"Project Facilities "** includes Company's equipment, wind turbines, step-up transformer(s), circuit breakers, necessary evacuation lines from Wind electric generators to the pooling substation/interconnecting substation , protective and associated equipment, communication and data collection equipments for transfer of required real time data to State Load Despatch Center, improvements, and other tangible and intangible assets , property and access rights and contract rights necessary for the construction, operation and maintenance of the electric wind generating facility to be located at the site specified in schedule 9 that produces energy output sold under this Agreement to the Buyers interconnection point.
- (aaf) **Project substation** means facilities located at project site which inter connect the project tie line and project transmission line.
- (aag) **Project Transmission line** means the transmission line connecting the project substation to the interconnection point/pooling substation.
- (aah) **"Project Site"** shall mean the area of land used by the Company for building, operating and maintaining the project as per the approved Technical proposal and as described in Schedule 9.
- (aai) **"Prudent Electrical Practices"** means the use of equipment, practices and methods, as required to comply with applicable Codes, Standards and regulations in India, to protect the Buyer/STU's System, employees, agents and customers from malfunctioning by the Project and to protect the project and company's employees and Agents from malfunctioning by the Kerala grid.
- (aaj) **"Prudent Utility Practices"** means the practices, methods, techniques and standards as changed from time to time that are generally accepted internationally for use in Electric Utility and Power generation industries (taking into account conditions in India), and used in prudent electric utility engineering and operations to design, engineer, construct, test, operate and maintain equipments lawfully, safely, efficiently and economically, as applicable to the power station of the size, service and type of the project and that generally conform to the manufacturer's operation and maintenance guidelines.
- (aak) **"Reginal Power Committee"** means the Committee established by resolution by the Central Government for a specific region for facilitating the integrated operation of the power system in the region.
- (aal) **"Scheduled Date of Completion"** means the date on which the project is completed in all respect and it shall be with in two years from the date of signing of this Agreement.

  
**CHIEF ENGINEER**  
 (Corporate Function)  
 KSE Board, Veyyandi Chavanam  
 Pattom, Thiruvananthapuram-4

For ASIAN STAR CO. LTD.,

  
**DIRECTOR**

Contd ..... 8



- (aam) "Schedule Outage" means a planned interruption or reduction of the generating capability of a unit or the power station that is not a Maintenance Outage.
- (aan) "State Load Despatch Centre" shall include Load Despatch Centre as defined in the Electricity Act, 2003.
- (aao) "Synchronisation Date" shall mean the date on which electric energy is generated and delivered in the Buyer/STU system for commissioning, testing and initial start up.
- (aap) "System Emergency" means a contingency in the Kerala grid/system of Buyer which threatens safe and reliable operation of such system.
- (aaq) "Tariff" shall mean as defined in Article 9
- (aar) "Tariff Year" means the Billing year as defined in clause (h)
- (aas) "Tariff period" means the period commencing from the date of commercial operation of the first generating unit up to the 20<sup>th</sup> year.
- (aat) "Technical Limits" means the limits and constraints described in Schedule 3 relating to operation and maintenance and dispatch of power from the Project.
- (aau) "Technical Proposal" means the the technical proposal given by the company to ANERT in the format prescribed by ANERT
- (aav) "Termination" means the early termination of this Agreement in accordance with the provisions thereof but shall not unless the context otherwise requires include the expiry of this Agreement due to efflux of time in the normal course.
- (aaw) "Termination Date" means the date on which the termination occurs.
- (aax) "Termination Notice" means the notice of Termination by either party to the other party in accordance with the provisions of this Agreement.
- (aay) "Tested Capacity" mean the capacity of the plant determined Pursuant to the Performance Tests.

## 1.2 Interpretation

In this Agreement, unless the context otherwise requires,

- (a) any reference to a statutory provision shall include such provision as is from time to time modified or re-enacted or consolidated so far as such modification or re-enactment or consolidation applies or is capable of applying to any transactions entered into hereunder;
- (b) references to Applicable Law shall include the laws, Acts, Ordinances, Rules, regulations, notifications, guidelines or byelaws which have the force of law in any State or Union Territory forming part of the Union of India;

  
**CHIEF ENGINEER**  
 (Corporate Planning)  
 KSE Board, Vidyuthi Bhavanam  
 Pattom, Thiruvananthapuram - 4

For ASIAN STAR CO. LTD.,

  
 DIRECTOR



- (c) the words importing singular shall include plural and vice versa, and words denoting natural persons shall include partnerships, firms, companies, corporations, joint ventures, trusts, associations, organisations or other legal entities;
- (d) the headings are for convenience of reference only and shall not be used in, and shall not affect, the construction or interpretation of this Agreement;
- (e) References to "construction" include investigation, design, engineering, procurement, delivery, transportation, installation, processing, fabrication, testing, commissioning and other activities incidental to the construction;
- (f) Any reference to any period of time shall mean a reference to that according to Indian Standard Time;
- (g) any reference to day shall mean a reference to a calendar day;
- (h) Any reference to month shall mean a reference to a calendar month;
- (i) The Annexure and the Schedules to this Agreement form an integral part of this Agreement and will be in full force and effect as though they were expressly set out in the body of this Agreement;
- (j) any reference at any time to any Agreement, deed, instrument, or document of any description shall be construed as reference to that Agreement, deed, instrument, or other document as amended, varied, supplemented, modified or suspended at the time of such reference;
- (k) references to recitals, Articles, sub-articles, clauses, or Schedules in this Agreement shall, except where the context otherwise requires, be deemed to be references to recitals, Articles, sub-articles, clauses and Schedules of or to this Agreement;
- (l) Any consent, approval, authorisation, notice, communication, information or report required under or pursuant to this Agreement from or by any party or the Government and/or the Independent Auditor shall be valid and effectual only if it is in writing under the hands of the party or Secretary (Principal) of the concerned Department or Independent Auditor or their duly authorised representative as the case may be, in this behalf and not otherwise;
- (m) Unless otherwise stated, any reference to any period commencing "from" a specified day or date and "til" or "until" a specified day or date shall include either such days or dates.

### 1.3 Measurements and Arithmetic Conventions

All measurements and calculations shall be in metric system and calculations done to 2 decimal places, with the third digit of 5 or above being rounded up and below 5 being rounded down.

  
**CHIEF ENGINEER**  
 (Corporate Planning)  
 KSE Board, Vyduthi Shivanam  
 Postom, Thiruvananthapuram - 4

For ASIAN STAR CO. LTD.,

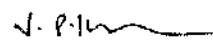
  
 DIRECTOR

#### 1.4 Ambiguities and Discrepancies

In case of ambiguities or discrepancies within this Agreement, the following shall apply:

- (a) between two Articles of this Agreement, the provisions of specific Articles relevant to the issue under consideration shall prevail over those in other Articles;
- (b) between the written description of the Drawing and the specifications and standards, the latter shall prevail;
- (c) between the dimension scaled from the Drawing and its specific written dimension, the latter shall prevail;
- (d) between any value written in numerals and that in words, the latter shall prevail.

### ARTICLE 2

#### TERM OF AGREEMENT AND CONDITIONS PRECEDENT

##### 2.1 Term of Agreement:

This Agreement shall be valid for the entire 20 years from the date of COD of the windmill project.

Provided that in the event of Termination, the term of this Agreement shall mean and be limited to the period commencing from date of this Agreement and ending with the Termination Date provided that the project will remain as an independent power producer for the entire tenure of the agreement

##### 2.2 Conditions Precedents

The obligations of Buyer and the Company under this Agreement shall become effective except for infirm energy as provided in relevant articles on fulfillment of conditions specified in subclauses a & b and below:

##### a) Obligations of the Company:

The Company shall have:

- (i) Achieved COD as per the terms of this agreement.
- (ii) Received all Clearances, statutory or otherwise required to execute and operate the Project; and
- (iii) Obtained approval of the Kerala State Electricity Regulatory Commission (KSERC) for the terms of this Agreement.
- (iv) Achieved financial closure with in 3 months from the date of signing of this Agreement.

Note:

The Company shall promptly inform the Buyer the date on which the conditions precedent pursuant to Article 2.2 has been fulfilled.

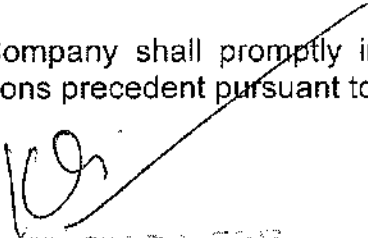
  
**CHIEF ENGINEER**  
 (Corporate Planning)  
 KSE Board, Industrial Estate,  
 Filton, Thiruvananthapuram

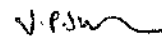
For ASIAN STAR CO. LTD.,  
  
**DIRECTOR**



**b) Obligations of the Buyer**

The Buyer shall have obtained all approvals, consents and licenses that are required to enable the Buyer to enter into this Agreement.

**2.3 Non Fulfillment of Conditions Precedent:**

Non- fulfillment of the conditions precedent, or refusal to waive any of the conditions precedent which is not fulfilled, on completion of two years from the date of signing this agreement unless extended by mutual Agreement, are grounds for termination of the Agreement without liability to either party.

**ARTICLE 3**

**PROJECT DESCRIPTION**

**a. Summary description:**

The Company shall construct operate and maintain the project facilities, including the project transmission line and project substation. The infrastructure development charge fixed by the Government in consultation with Board shall be remitted by the developer to Kerala State Electricity Board /State Transmission Utility. A complete description of the facility, including nominal capacity of the project, identification of number and nominal capacity of the generating units and capacity of wind turbines, other equipment and components that comprise the facility are provided in Annexure I.

**b. Site**

- (1) The facility shall be located at the area generally described as:

Project Name	: M/s.Asian Star Company Limited
Village	: Kottathara
Location/ District	: Agali / Palakkad
Longitude and Latitude	: 76° 42' 44.0" / 11° 05' 32.4"
State/Country	: Kerala / India

- (2) A scaled map that identifies the location of the project facility, project transmission and substation, interconnection facilities, and significant ancillary facilities including the facilities at point of delivery, is included in Annexure I.

**C. General Design and Construction of the Project Facility**

Developer shall construct the project facility constructed in a workmanlike, professional manner according to prudent utility practices. The facility shall be:

- (1) Capable of supplying energy output in compliance with the requirements of power purchase agreement.

  
**CHIEF ENGINEER**  
 (Corporate Planning)  
 KSE Board, Vidyuthi Bhavanam  
 Pattom, Thiruvananthapuram -4

For ASIAN STAR CO. LTD

  
**DIRECTOR**

- (2) Capable of operating at power levels as specified in the power purchase agreement.
- (3) Equipped with protective devices and generator control systems designed and operating in accordance with the power purchase agreement and prudent utility practices.
- (4) Equipped with necessary Supervisory Control And Data Acquisition arrangements and Communication facilities to provide unit wise injection of MW, MVAR, bus voltage, frequency and isolator status and any other Relevant parameters in real time to State Load Dispatch Center in a format compatible to the existing Supervisory Control And Data Acquisition system of State Load Dispatch Center . Any interfacing issues and Protocol issues have to be sorted out by the company at their expenditure.

#### ARTICLE 4

#### RESPONSIBILITIES OF THE COMPANY AND THE BUYER

##### 4.1 Responsibilities of Company

- a) The Company shall operate the Project in a safe manner and shall comply with the statutory/regulatory measures taken by the Government of Kerala /Government of India with respect to the operation of the Project.
- b) The Company shall generate power at 690V, stepped up to 33KV and transmitted to inter connecting sub station at 33KV located at Agali, which is at a distance of 7Km from the project switch yard.
- c) The Company shall at its own cost maintain the tie line up to pooling substation/interconnecting substation in accordance with the specification and requirements as notified to the Company by the Buyer at its own cost and in accordance with Prudent Utility Practices. The tie lines so constructed shall remain as dedicated tie line.
- d) The Company shall its own cost and expenses subscribe purchase and maintain by due re-instatement or otherwise such insurance as may be necessary till the expiry of this Agreement.
- e) The Company shall operate and maintain the Project during the term of the Agreement, in accordance with:
  - 1. Prudent Utility Practices;
  - 2. All applicable laws and directives;
  - 3. The manuals, instructions and manufacturer's guidelines supplied by construction contractors, manufacturers of equipments/suppliers etc;
  - 4. Despatch Instructions
  - 5. Certified power curve
- f) The Company shall give three months advance notice to the Buyer intimating the readiness of each generating unit to be electrically synchronised for the first time and connected to the inter- connecting station/ sub station bus bars. In case of developers who are constructing the power evacuation system as per the master plan of KSEB, the notice period shall be one week.

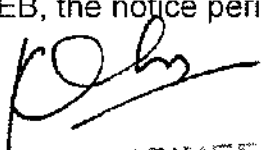
  
 CHIEF ENGINEER  
 (Corporate Planning)  
 KSE Board, Vidyutni Bhavanam

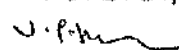
For ASIAN STAR CO. LTD.,  
  
 DIRECTOR



- g) The Company shall give Buyer 60 days notice before COD of each generating unit/Project. In case of developers who are constructing the power evacuation system as per the master plan of Kerala State Electricity Board, the notice period shall be three days.
- (h) The Company shall ensure that reactive power as per grid requirement specified in real time by State Load Despatch Centre corresponding to active power generation pumped into Kerala State Electricity Board/STU grid system upto a minimum power factor of 0.95 lag. The company agrees to provide sufficient capacity of capacitors, in its WEG, to minimize the drawal of reactive power from the Board's grid and the capacitors should get cut off automatically so that the power factor shall be maintained above 0.95 and to control the voltage regulation within 10% of the rated voltage at the point of supply.
- (i) The Company shall, in case constraints in the Kerala grid or in Buyer's evacuation system, back down the generation till such time normalcy is restored as directed by State Load Despatch Centre .
- (j) The Company shall prepare the Operation and Maintenance schedule and get it approved by the Buyer / State Load Despatch Centre within 60 days before each Tariff Year.
- (k) The company shall submit all financing documents to the buyer and Kerala State Electricity Regulatory Commission within 30 days of signing thereof.
- (l) The Company shall maintain accurate and up-to-date operating logs, records and monthly reports regarding the Operation and maintenance of the project which shall include details of power output, other operating data, repairs performed and status of equipment. All such records shall be maintained for a minimum of twenty four (24) months after the creation of such reports or data and for any additional length of time required by regulatory agencies having jurisdiction over the parties. Upon expiry of the aforesaid period, the Company shall hand over such records to the buyer/State Transmission Utility.
- (m) The company acknowledge that wind turbines have the potential to produce substantial carbon dioxide credits and other environmental air quality credits and related emission reduction credits or Clean Development Mechanism benefits related to the generation of energy after commercial operation. The parties agree that any and all such credits or benefits shall be shared equally between the company and the buyer/STU. In furtherance of the foregoing, company hereby agree to pursue efforts in organising such credits or benefits.

#### 4.2 Responsibilities of Buyer

- (a) The Buyer shall provide all possible assistance to the Company in its initiatives in obtaining all way-leaves required for construction, installation, operation and maintenance of the Project including the transmission lines.
- (b) The Buyer shall give the Company 15 days notice regarding the readiness of the interconnection facility at the switching sub station/grid for the full evacuation and utilisation of energy/power from the Project.
- (c) The Buyer shall purchase all the electricity made available by the Company at the interconnection Point subject to system constraints, instructions of state load despatch centre and Force Majeure conditions.

  
**CHIEF ENGINEER**  
 (Corporate Planning)  
 KSE Board, Vidyuthi Bhavanam

For ASIAN STAR CO. LTD.,

  
**DIRECTOR**

Contd ..... 14

### 4.3 Mutual Covenants

Each party will duly pay all rents, taxes, cesses, fees, revenues, assessments, duties, other outgoing and other amounts owed by it and will observe all the rules and regulations pertaining to the same, and will not do or omit to do or suffer to be done anything which could reasonably be expected to adversely affect or prejudice the interest and rights of the other party in any manner whatsoever.

## ARTICLE 5

### COMMISSIONING AND ENTRY INTO COMMERCIAL SERVICE

#### 5.1 Performance Test to establish Entry into Commercial Service

The Company shall conduct performance tests in accordance with the procedure prescribed in Schedule 2, for entry of the generating unit (s) /project, as the case may be, into commercial service. The company shall, at least 7 days prior to the Date of Completion, give the Buyer notice of the performance test and shall invite Buyer's representatives and the agency authorized by Government to attend the same.

#### 5.2 Certificate of Commercial Operation

The Buyer or authorized agency of Government shall issue Certificate of Commercial Operation of the Project, to the Company on successful completion of the Performance Tests.

For the purposes of this clause each of the generating unit and/or the Project shall be deemed to enter into commercial service if the Company has demonstrated fourteen day's operation with a minimum of one day's continuous operation of such generating unit and/or the Project and during such period the Tested capacity of generating unit(s)/Project, as the case may be, is not less than ninety percent (90%) of the Nominal Capacity for a minimum period of twenty four (24) consecutive hours within the electrical system characteristics and functional specifications, provided in Schedule 4 and Technical Limits provided in Schedule 3.

#### 5.3 Provisional Certificate of Commercial Operation:

- a. If due to non-availability of required wind velocity, the Performance Tests cannot be carried out by the Company, the Buyer or agency authorized by Government may issue a Provisional Certificate of Commercial Operation of the Project to the Company after carrying out the tests that are possible to be conducted with the available wind velocity.
- b. The Provisional Certificate shall be valid for a period of 12 months from the date of issue or upto the date on which the Performance tests are conducted, whichever is earlier. The Board/State Transmission Utility shall purchase the energy generated from the generating unit/Project as per the tariff determined by KSERC for a period of twelve months from the date of issuance of Provisional Certificate subject to the condition that the company shall establish a Bank Guarantee towards the provisional payments made by Board/State Transmission Utility till the declaration of Commercial Operation.

  
CHIEF ENGINEER  
(Corporate Planning)

For ASIAN STAR CO. LTD.,

  
DIRECTOR

Contd ..... 15



In the event of the Performance Tests demonstrating that the Company has not satisfied the parameters set out in article 5.2, and then the Provisional Certificate shall stand cancelled. In such an event the power generated by the Company shall be deemed to be Infirm Power and the tariff thereof shall be the tariff applicable for Infirm Power, which is Rs 0.25/ unit. The additional payment made by the Buyer shall be adjusted against Bank guarantee submitted by the company as per sub clause (b).

#### 5.4 Shortfall in Nominal Capacity

If the Tested Capacity is less than the Nominal Capacity, the Company shall endeavour to bring the capacity to Nominal Capacity within a period of sixty days. If the Company fails to do so, the Tested Capacity from the Commercial operation of the unit/project shall be treated as Guaranteed Capacity.

#### 5.5 Excess of Nominal Capacity

Where the Tested capacity of a generating unit /project is more than the Nominal capacity of the unit/project, Nominal capacity shall be taken as the tested capacity of the unit /project, as the case may be.

### ARTICLE 6

#### SALE AND PURCHASE OF ENERGY

6.1 The Company agrees to sell and the Buyer agrees to purchase the entire energy made available by the Company at the interconnection point as per the Tariff specified in the Article 9 during the term of this agreement or till the termination date in the event of termination.

It is further agreed by, and between the parties that the Project will be operated on despatchable basis and that the company shall operate the project at the nominal capacity or less, as may be directed by the Buyer from time to time, subject to Technical limits, Prudent Utility Practices, availability declaration by the Company and at a power factor as per Article 4.1 (h) and within the frequency range between 48.5 Hz and 51.0 Hz.

#### 6.2 Tariff for Infirm Energy:

The Infirm Energy shall be metered at the interconnection Point as per provisions under Article 7, and delivered at the Inter Connection point/grid. The Buyer shall pay for the metered Infirm Energy at the tariff as mentioned in Article 9.3.

#### 6.3 Carbon Credit

The benefits accruing on account of carbon credit for the project shall be shared equally between the STU/buyer and the company.

  
**CHIEF ENGINEER**  
 (Capital Planning)  
 KSE Board, Vidyarthi Bhavan  
 Palam, Thanjavur/621 014

For ASIAN STAR CO LTD

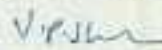
  
**DIRECTOR**

**ARTICLE 7****METERING**

- 7.1 The Company shall install a main meter and a check meter at the Interconnection Point and at the high voltage side of the step up transformer installed at the project site and a fall back meter of same specification at the generator end in accordance with Kerala State Electricity Grid Code.
- 7.2 Meters shall be capable of measuring and recording the following parameters for various time/frequency blocks as per Prudent Utility Practices. Meters shall have provision to download and transmit following real time data to State Load Despatch Centre in format and protocol suitable to State Load Despatch Centre.
- a. Active Energy (kwh) and Reactive Energy ( kvarh)
  - b. Instantaneous voltage, current, power factor
  - c. Frequency
  - d. Maximum demand in kva/kw for each demand period and for the total period since the last reset.
  - e. Kwh/kvarh since last reading
  - f. Real time and time of day metering; and
  - g. Number of resets
- 7.3 The Parties shall undertake a joint reading of the Meters on the date of synchronisation, on COD, and subsequently on the first working day of every month at pre-appointed time as settled between the Parties.
- 7.4 All Meters shall be jointly inspected, and sealed by authorised representatives on behalf of the Buyer, the Company and State Transmission Utility.
- 7.5 The Meters shall be calibrated annually as specified in metering code/KSEGC and tested for accuracy semi annually and shall be treated as working satisfactorily so long as the errors are within the limits prescribed for meters of the class. The readings of the Main Meters recorded jointly by the parties will form the basis for billing, so long as the results of the half-yearly checks thereof are within the prescribed limits.
- 7.6 In the event that Computer Monitoring System is found to be inaccurate by more than two percent (2%), Fall back meter reading may be adopted. If Fall back meter is also faulty, the parties shall estimate the amount of Power generation during the period of inaccurate measurements based on the certified power curve of machine and wind data as per wind mast installed at project premises and the actual machine availability achieved.
- 7.7 All the tests on the Meters shall be conducted jointly by the representatives of both the parties and the results and corrections so arrived at mutually will be recorded in writing and will be applicable and binding on both the parties.
- 7.8 The calibration and the maintenance of the Meters shall be done by the Buyer at the cost of the Company.
- 7.9 If intentional tampering of metering cubicle or Energy Meters at the Company's Power Plant is detected, the Buyer has the option to withdraw from the PPA and also take the action under applicable laws and Buyer's supply regulations.

  
**CHIEF ENGINEER**  
 (Corporate Planning)

KSE Board, Vidyuthi Bhavanam  
 Pattom, Thiruvananthapuram - 4

For ASIAN STAR CO. LTD.,

  
**DIRECTOR**

**ARTICLE 8****PLANT OPERATION AND MAINTENANCE****8.1 Operation of the Project**

- a) The Company shall operate and maintain the Project in accordance with the Operation and Maintenance Schedule submitted by the Company and approved by the Buyer under Section 4 (1) of this Agreement.
- b) The Company shall supply the generated electrical energy to the Buyer in accordance with the instructions of the State Load Despatch Centre.
- c) The Company agrees to provide suitable automatic device so that the Wind Electric Generator/s should get cut off automatically when the grid supply fails.
- d) The Company agrees that the Buyer will not be responsible for any damage to its Wind Electric Generators resulting from parallel operation with the grid and that the Buyer shall not be liable to pay any compensation for any such damage(s).
- e) There should not be any fluctuations or disturbances to the grid or other consumers supplied by the grid due to paralleling of the Wind Electric Generator/s. The Company shall provide adequate protection as required by the Buyer to facilitate safe parallel operation of the Wind Electric Generator/s with the grid and to prevent disturbances in the grid.
- f) The Company shall make good the losses, if any, due to any damages that may occur to the equipment/lines of the Buyer resulting on account of parallel operation of its Wind Electric Generators.
- g) Pursuant to issuance of a notice for the purposes and conferring reasonable opportunity of hearing, the Buyer may opt for disconnection of the Company's Wind Electric Generators from the Buyer grid if forced oscillation occurs at any time while the Wind Electric Generator/s are in operation.
- h) In case of unsymmetrical fault on HV bus, the Company is bound to share the fault current according to impedance in the circuit. To meet such contingency and for safe operation of generator, the Company agrees to provide separate overload relay on such phase and earth fault relay. It is further agreed that under no circumstances, these relays should be bypassed.
- i) Functioning of the relays should be calibrated and tested by competent authorities and report maintained.

**8.2 Procedures to be Determined**

The Company shall submit the following to the Buyer 30 days prior to the Scheduled Date of Completion of the first generating unit/Project:

- a. Detailed procedure for the co-ordination of Inter Connection Facility and transmission facilities including inter-tripping schedules;
- b. Commissioning and testing arrangements;
- c. Despatch procedures;
- d. Procedures for maintenance of records;
- e. Emergency plans;
- f. Meter reading statement format; and
- g. Supply of Generation details from the computer monitoring station, procedure, periodicity, recording, verification, notification, etc.

  
**CHIEF ENGINEER**  
 (Corporate Planning)  
 KSE Board, Vidyuthi Bhavanam  
 Thiruvananthapuram-4

For ASIAN STAR CO. LTD.,

  
**DIRECTOR**



**8.3** The Operating Procedures shall be consistent with the following, it being clearly understood that in the event of inconsistency between two or more of the following, the order of priority as between them shall be the order in which they are placed, with 'applicable law' being the first:

- (a) Applicable law
- (b) Grid code
- (c) Terms and conditions of this Agreement
- (d) Functional Specifications
- (e) Technical Specifications
- (f) Prudent Utility Practices

**8.4 Outages**

- (a) The Company shall submit a written schedule to the Buyer/SLDC of its desired Scheduled outage periods, at least 60 days before the commencement of each Tariff year. Within 15 days of the receipt of the same, the Buyer shall notify the Company in writing if the requested Scheduled outage periods are acceptable to the Buyer. If there are any requested Scheduled outage periods that the Buyer cannot accept, the Buyer shall advise the Company of the time period when such proposed Scheduled outage can be rescheduled, which rescheduled time periods shall be of equal duration as the Scheduled outage period proposed by the Company. The Buyer may only request a revision to the Company's proposed Scheduled outage to accommodate the reasonable requirement of the Buyer and the Grid System subject to Prudent Utility Practices and this Agreement, the Company shall use reasonable efforts to accommodate all the reasonable requests of the Buyer. If the Buyer does not notify the Company in writing within 15 days of receipt of the written schedule of desired Scheduled outages, it shall be deemed to have consented to the desired Schedule outage as per the written schedule. A minimum of fifteen day's notice shall be given by the Company to the Buyer prior to taking the shutdown for maintenance of the Project.
- (b) Either party may, upon written notice given not later than 30 days prior to a Scheduled outage, request the rescheduling of such Scheduled outage. Any rescheduling of a Scheduled Outage in accordance with Section (a) shall be subject to mutual approval of the Parties, which approval shall not be unreasonably withheld or delayed.
- (c) The Company shall use reasonable efforts to give advance notice to the Buyer to the extent feasible of any unscheduled outage and shall provide the Buyer with an estimate of the duration and scope of such outage. Following any unscheduled outage, the Company shall use reasonable efforts to return the equipment of the Unit/Project as soon as reasonably practicable to the level of generation immediately prior to such unscheduled outage.
- (d) Except when the equipment of the station is under forced shutdown or is under Scheduled outage, such equipment or any auxiliaries or works in relation thereto shall not be taken out for maintenance, testing or overhaul resulting in outages or reduced generation unless mutually agreed upon by both the Parties.

  
 (Company Representative)  
 KCE Energy, 10000, 10000, 10000  
 10000, 10000, 10000, 10000

For ASIAN STAR CO. LTD.,

  
 DIRECTOR

**ARTICLE 9****TARIFF**

- 9.1 **“Tariff Period”**: Tariff Period shall be reckoned from COD of the first generating unit till the end of the 20<sup>th</sup> year from the date of COD.
- 9.2 **“Single Part Tariff”**: The Tariff shall be as mentioned in the Schedule 10.
- 9.3 **“Infirm Energy Rate”**: In respect of the sale of Infirm Energy if any, the Buyer shall pay a tariff of Rs.0.25/Kwh.
- 9.4. In the event of the company drawing more units than the units of energy delivered at the interconnection during a billing month, then the Buyer shall charge the net metered energy delivered at the interconnection point as per the appropriate tariff.
- 9.5 Reactive power at lagging power factor up to 10% of the net active energy generated shall be charged at 25 Ps/Kvarh. For drawal of more than 10% of the net active energy 50Ps/Kvarh shall be charged for the total drawal.

**ARTICLE 10****BILLING AND PAYMENTS****10.1 Monthly Bills**

The Company shall furnish a bill to the Buyer on Billing Date in such a form as may be mutually agreed by the Buyer and the Company for the billing month. Each bill for a billing month shall be payable by the Buyer on the Due Date of Payment. The tariff invoice shall be

Delivered energy pertaining to the project =  $x1 - (x1 \times z \%)$

Where x1 is the reading of the energy meter installed at the project site.

Z = percentage transmission loss incurred in the transmission line between the project and the interconnection point and shall be

$$Z = \frac{(x1+x2+x3+-----) - Y}{(x1+x2+x3+-----)} \times 100$$

y= reading of the energy meter installed at the interconnecting point.

x2, x3 , x4,....etc. are the readings of the energy meters installed at the various wind mill projects set up in the area and connected to the interconnecting substation.

  
 Director  
 Asian Star Co. Ltd.  
 Plot No. 1, Sector 1, Gurgaon  
 Haryana, India

For ASIAN STAR CO. LTD.,



DIRECTOR

**10.2 Billing**

The monthly bill will be assumed as undisputed unless the Buyer informs the company within 5 working days of receipt that the bill is disputed with the reasons thereof. In any event the Buyer shall pay the Bill on the Due Date of Payment and in the event of resolution of dispute the same shall be resolved in accordance with sub article 10.5. In the event of dispute, the buyer shall pay 90% of the bill amount only and balance will be paid only after the settlement of the dispute.

**10.3 Billing of Infirm Energy**

The Company shall submit to the Buyer a separate Bill for Infirm Energy metered at the interconnecting point within 30 (thirty) days from COD of each generating unit. The tariff for Infirm Energy shall be as per sub article 9.3 of this Agreement.

**10.4 Billing for Energy Purchased by the Company**

Energy purchased by the Company from the Buyer for consumption or during maintenance / shutdown period of the power plant shall be billed by the buyer on monthly basis as per the appropriate tariff.

**10.5 Supplementary Bill**

The adjustments, if any, on account of any additional claims or errors in the billing for a month shall be made through supplementary bills and shall also be paid / adjusted with the next month's bill.

**10.6 Payment**

Buyer shall make the payments of the amounts due in Indian Rupees by cheque on or before the due date of payment.

**10.7 Penalty for delay in payment**

The monthly bill for the energy metered at the interconnecting point shall be paid by the buyer on or before the due date of the payment. If the buyer does not pay the amount due within 60 days from the date of billing, then the buyer shall pay 1.25% interest rate per month for such payment from the date on which the payment was due until the payment is made in full.

**10.8 Rebates for Prompt Payment**

If the Buyer pays the amount due with in the due date of payment, then a rebate of 2% shall be given to the Buyer by the Company."

**ARTICLE 11****INSURANCE****11.1 Insurance:**

The Company shall at its cost and expense, purchase and maintain by re-instatement or otherwise, during the Operations Period of insurance against:

  
**CHIEF ENGINEER**  
 (Corporate Planning)  
 VCC Pharr Vvdwulhi Zhavannam

For ASIAN STAR CO. LTD.,

  
**DIRECTOR**  
 Contd ..... 21



- (i) loss, damage or destruction of the Project Facilities, at replacement value;
- (ii) the Company's general liability arising out of the License;
- (iii) liability to third parties;
- (iv) Fire Protection coverage insurance; and
- (v) any other insurance that may be necessary to protect the Company, its employees and its assets against loss, damage, destruction, business interruption or loss of profit including insurance against all Force Majeuro Events that are insurable.

### 11.2 Evidence of Insurance

The Company shall provide annually to the Government/Buyer copies of all insurance policies (or appropriate endorsements, certifications or other satisfactory evidence of insurance) obtained by the Company in accordance with this Agreement.

### 11.3 Validity of Insurance

The Company shall from time to time promptly pay insurance premium, keep the insurance policies in force and valid throughout the Agreement period and furnish copies thereof to the Government/Buyer. The insurance policy shall not be cancelled or terminated unless 10 days' clear notice of cancellation is provided to the Buyer in writing.

Provided that if at any time the Company fails to obtain or maintain in full force and effect any or all of the insurance causing the buyer to incur any expense, such sums incurred by the Government/Buyer therefore shall be reimbursed by the Company to the Government/Buyer together with interest thereon at 5 % p.a over SBI PLR from the date the respective sums were incurred by the Government/Buyer, within 7 days from the receipt of claim in respect thereof made by the Buyer.

### 11.4 Application of Insurance Proceeds

Subject to the provisions of the Financing Documents and unless otherwise provided herein; the proceeds of all insurance policies received shall be promptly applied by the Company towards repair, renovation, restoration or re-instatement of the Project Facilities or any part thereof which may have been damaged or destroyed. The Company may designate the Lenders as the loss payees under the insurance policies or assign the insurance policies in their favour as security for the financial assistance provided by them to the Project. The Company shall carry out such repair, renovation, restoration or re-instatement to the extent possible in such manner that the Project Facilities after such repair, renovation, restoration or re-instatement be as far as possible in the same condition as it were prior to such damage or destruction, except for normal wear and tear.

## ARTICLE 12

### PROTECTION SYSTEM

- 12.1 The Company shall be responsible for designing protection system of the entire equipment for safe operation of the Project/Project Facilities as per the Prudent Utility Practices.

  
 CHIEF ENGINEER  
 (Corporate Planning)

For ASIAN STAR CO. LTD.,

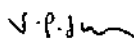
  
 DIRECTOR

Contd ..... 22

- 12.2 The Company shall ensure that the protective relays for the Project Facilities shall be suitably graded and co-ordinated with the Buyer's relays as may be required by the Buyer. The protection scheme shall be approved by the STU.
- 12.3 The company shall design, construct, test, control, operate and maintain the project in accordance with, Prudent Utility Practices and Prudent Electrical Practices

### **ARTICLE 13**

#### **REPRESENTATION AND WARRANTIES**

##### **13.1 Representation and Warranties of the Company**

The Company represents and warrants to the Buyer that:

- (a) the Company duly organised and validly existing under laws of India and has all requisite legal power and authority to execute this Agreement and carry out the terms, conditions and provisions hereof;
- (b) this Agreement constitutes valid, legal and binding obligation of the Company, enforceable in accordance with the terms hereof, except as enforceability may be limited by applicable bankruptcy, insolvency, reorganisation, moratorium or other similar laws affecting creditor's rights generally to the extent that the remedies of specific performance, injunctive relief and other forms of equitable relief are subject to equitable defences; the discretion of the court before which any proceeding thereof may be brought and the principles of Equity in general;
- (c) there are no actions, suits or proceedings pending or to the Company's knowledge threatened, against or affecting the company before any court or administrative body or arbitral tribunal that might materially adversely affect the ability of the Company to meet and carry out its obligations under this Agreement; and
- (d) the execution and delivery by the Company of this Agreement has been duly authorised by all requisite corporate or partnership action, and will not contravene any provision of, or constitute a default under any other related Agreement or instrument to which it is a party or by which it or its property may be bound.

##### **13.2 Representations and Warranties of Buyer**

Buyer represents and warrants to the Company that:

- (a) the Buyer shall be the Board, a statutory body duly constituted under the Electricity (Supply) Act 1948 and continuing as STU and Licensee under section 172(a) of Electricity Act 2003 and has all requisite legal power and authority to execute this Agreement and carry out the terms, conditions and provisions hereof;

For ASIAN STAR CO. LTD.,

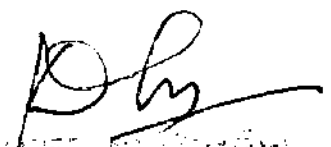

DIRECTOR

  
 CHIEF EXECUTIVE OFFICER  
 (Company Name)  
 PSE Board, (Company Name)  
 PSE Board, (Company Name)

- (b) this Agreement constitutes the valid legal and binding obligation of the Buyer, enforceable in accordance with the terms hereof except as the enforceability may be limited by applicable bankruptcy, insolvency, reorganisation, moratorium or other similar laws affecting creditor's rights generally to the extent that the remedies of specific performance, injunctive relief and other forms of equitable relief are subject to equitable defences, discretion of the court before which any proceeding thereof may be brought and the principles of Equity in general;
- (c) There are no actions, suits or proceedings pending or to the Buyer's knowledge threatened, against or affecting the Buyer before any court or administrative body or arbitral tribunal that might materially adversely affect the ability of the Buyer to meet and carry out its obligations under this Agreement; and
- (d) the execution and delivery by the Buyer of this Agreement has been duly authorised by all requisite corporate action and will not contravene any provision of, or constitute a default under any other related Agreement or instrument to which it is a party or by which it or its property may be bound.

## ARTICLE 14

### FORCE MAJEURE

#### 14.1 Force Majeure Events

Force Majeuro Event means any of the Non-Political Events or the Political Events as set out in clauses 2 and 3 of this article including the impact/consequence thereof which:

- (a) is beyond the control of the party claiming to be affected thereby (the "Affected Party"),
- (b) causes a Material Adverse Effect and prevents the Affected party from performing or discharging its obligations under this Agreement; and
- (c) the affected party has been unable to overcome or prevent despite exercise of due care and diligence.

#### 14.2 Non-Political Events

Any of the following events which prevents the Affected Party from performing any of its obligations for a continuous period of not less than 7 days from the date of its occurrence, shall constitute a Non-Political Event:

- a) earthquake, flood, inundation, landslide;
- b) storm, tempest, hurricane, cyclone, lightning, thunder or other extreme atmospheric disturbances;
- c) fire caused by reasons not attributable to the Company or the Contractor or any of the employees or agents of the Company or the Contractor;

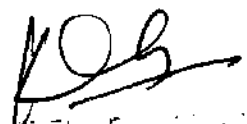
  
 Director  
 ASIAN STAR CO. LTD.

For ASIAN STAR CO. LTD.,

  
 DIRECTOR



- d) acts of terrorism;
- e) illegal strikes, boycotts, labour disruptions or any other industrial disturbances not arising on account of the acts or omissions of the Company or the Contractor;
- f) war, hostilities (whether war be declared or not);
- g) invasion, act of foreign enemy, rebellion, riots, weapon conflict or military actions, civil war;
- h) ionizing, radiation, contamination by radio activity from nuclear fuel, any nuclear waste, radioactive toxic explosion;
- i) volcanic eruptions;
- j) any other events of like nature; and
- k) any failure or delay of a contractor caused by any of the aforementioned non-political events, for which no offsetting compensation is payable to the Company by or on behalf of the contractor.

#### 14.3 Political Events

Any of the following events shall constitute a Political Event; namely:-

- (a) Change in Law
- (b) Any failure or delay of a contractor caused by any of the aforementioned political event for which no offsetting compensation is payable to the company by or on behalf of the contractor.

#### 14.4 Obligations of the Parties

##### (a) Obligation to Intimate

- (i) As soon as may be practicable and in any case within 7 days of the date of occurrence of a Force Majeure Event or the date of knowledge thereof, the affected party shall intimate the other party of the Force Majeure Event setting out, inter alia, the following in reasonable detail:
  - (ia) the nature and extent of the Force Majeure Event and classification of the same as political/non political;
  - (ib) the estimated Force Majeure period;
  - (ic) the nature of and the extent to which, performance of any of its obligations under this Agreement is affected by the Force Majeure Event;
  - (id) the measures which the affected party has taken or Proposes to take to alleviate/mitigate the impact of the Force Majeure Event and to resume performance of such of its obligations affected thereby; and

  
 K. O. Srinivasan  
 Director (Finance)  
 K. O. Srinivasan, Director (Finance)

For ASIAN STAR CO. LTD.,



DIRECTOR  
 Contd ..... 25

- (ie) any other relevant information concerning the Force Majeure Event, and /or the rights and obligations of the parties under this Agreement.
- (ii) As soon as practicable and in any case within 5 days of intimation by the Affected party in accordance with the preceding sub clause a(i), the parties shall meet, hold discussions in good faith and where necessary conduct physical inspection/survey of the Project / Project Facilities in order to:
- (iia) finalise the classification of Force Majeure event mentioned in item (ia) of clause (i) above;
  - (iib) assess the impact of the underlying Force Majeure Event;
  - (iic) to determine the likely duration of Force Majeure Period; and
  - (iid) to formulate damage mitigation measures and steps to be undertaken by the Parties for resumption of obligations the performance of which shall have been affected by the underlying Force Majeure Event.
- (iii) The affected party shall during the Force Majeure Period provide the other party with regular (not less than weekly) reports concerning the matters set out in the preceding sub clause (ii) as also any information, details or document, which the other party may reasonably require.

**(b) Performance of Obligations**

If the affected party is rendered wholly or partially unable to perform any of its obligations under this Agreement because of a Force Majeure Event (Political/Non Political), it shall be excused from performance of such obligations to the extent to which it is unable to perform the same on account of such Force Majeure Event provided that:-

- (i) the excuse from performance shall be of no greater scope and of no longer duration than is necessitated by the Force Majeure Event;
- (ii) the affected party shall make all reasonable efforts to mitigate or limit damage, if any, caused or is likely to be caused to the Project Facilities as a result of the Force Majeure Event and to restore the Project Facilities, in accordance with the Good Industry Practice and its relative obligations under this Agreement;
- (iii) the affected party shall take all remedial measures including duly prosecuting and exhausting all such remedies available to the affected party under the Applicable Laws;
- (iv) when the affected party is able to resume performance of its obligations under this Agreement, it shall give to the other Party written notice to that effect and shall promptly resume performance of its obligations hereunder;

The affected party shall continue to perform such of its obligations which are not affected by the Force Majeure Event and which are capable of being performed in accordance with this Agreement.

  
**CHIEF ENGINEER**  
 (Corporate Planning)  
 KSE Board, Vidyuthi Bhavanam

For ASIAN STAR CO. LTD.,



**DIRECTOR**



**ARTICLE 15****EVENTS OF DEFAULT AND TERMINATION****15.1 Events of Default****a) Company Event of Default**

Any of the following events shall constitute an event of default by the Company ("Company Event of Default") unless such event has occurred as a result of a Buyer Event of Default or a Force Majeure Event.

- (i) If the Project is designed, constructed or completed in a manner that materially deviates from the provisions of the Technical proposal Clearance or in a manner that deviated from Prudent Utility Practices.
- (ii) if the Company wilfully or recklessly fails in material respect to operate and maintain the Project in accordance with Prudent Utility Practices or as per the requirements of this Agreement;
- (iii) if the Company does not comply with Despatch Instructions,
- (iv) Any representation made or warranties given by the Company under this agreement is found to be false or misleading.
- (v) The Company has otherwise been in Material Breach of any of its other obligations under this Agreement.

**(b) Buyer Event of Default**

Any of the following events shall constitute an event of default by Buyer ("Buyer Event of Default"), unless caused by a Company Event of Default or a Force Majeure Event:

- (i) Buyer is in breach of any of its obligations under this Agreement except those for which specific remedy has been provided elsewhere, and has failed to cure such breach within 15 (Fifteen) days of receipt of notice thereof issued by the Company.
- (ii) Buyer has repudiated this Agreement or otherwise expressed its intention not to be bound by this Agreement.
- (iii) Buyer has failed to make payment of undisputed amount of the monthly bills of two consecutive operational months (60 days), within the date of payment in respect of the monthly bill for second such consecutive month without any lawful excuse;
- iv). Buyer has delayed the payment of Tariff that has fallen due in terms of this Agreement beyond 2 consecutive months without any lawful excuse.

  
**CHIEF ENGINEER**  
 (Corporate Planning)  
 KSE Board, Vidyuthi Bhavanam  
 Pallam, Thiruvananthapuram - 4

**For ASIAN STAR CO. LTD.,**

  
**DIRECTOR**



## 15.2 Termination due to Company Events of Default

### (a) Termination

- (i) Without prejudice to any other right or remedy which Buyer may have in respect thereof under this Agreement, upon the occurrence of a Company Event of Default, the Buyer shall be entitled to terminate this Agreement as hereinafter provided, under due intimation to the Government.
- (ii) If the Buyer decides to terminate this Agreement pursuant to preceding sub-clause (i), it shall in the first instance issue Preliminary Notice to the Company. Within 30 days of receipt of the Preliminary Notice, the Company shall submit to the Buyer in sufficient detail, the manner in which it proposes to cure the underlying Event of Default (the "Company's Proposal to Rectify"). In case of non submission of the Company's Proposal to Rectify within the said period of 30 days, the Buyer shall be entitled to terminate this Agreement by issuing Termination Notice.
- (iii) If the Company's Proposal to Rectify is submitted within the period stipulated there fore, the Company shall have further period of 30 days to remedy/ cure the underlying Event of Default. If, however the Company fails to remedy/ cure the underlying Event of Default within such further period allowed, the Buyer shall be entitled to terminate this Agreement by issue of Termination Notice.
- (iv) However if the buyer decides to terminate this agreement the company shall continue to generate power and the buyer shall purchase the power as long as the complete termination of this agreement is made and enforced, and the same terms and conditions set forth in this agreement shall be binding for the buyer and the company, till the termination process is completed.

### b. Termination Notice

If Buyer having become entitled to do so decides to terminate this Agreement pursuant to the preceding clause (a), it shall issue Termination Notice setting out:

- (i) in sufficient detail the underlying Event of Default;
- (ii) the Termination Date which shall be a date occurring not earlier than 60 days from the date of Termination Notice;
- (iii) any other relevant information.
- (iv) In the event the company decides to give an appeal petition to the Kerala State Electricity Regulatory Commission about its grievances, the buyer shall continue to carry out its obligations under this agreement until the final verdict of the KSERC.

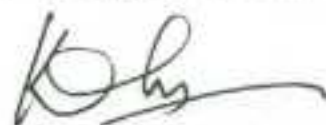

CHIEF ENGINEER  
(Corporate Planning)  
KSE Board, Vidyuthi Bhavanam  
Pattom, Thiruvananthapuram - 3

For ASIAN STAR CO. LTD.,



DIRECTOR

### C Obligation of Parties

Following issue of Termination Notice by Buyer, the Parties (Company/Buyer) shall promptly take all such steps as may be necessary or required to ensure that,

- (i) until Termination the Parties shall, to the fullest extent possible, discharge their respective obligations so as to maintain the continuity of service to the users of the Project Facilities; and

### (d) Withdrawal of Termination Notice

Notwithstanding anything inconsistent contained in this Agreement, if the Company who has been served with the Termination Notice cures the underlying Event of Default to the satisfaction of Buyer at any time before the Termination occurs, the Termination Notice shall be withdrawn by Buyer which had issued the same or the Kerala State Electricity Regulatory Commission verdict shall be final and binding as to the continuance of this agreement.

### 15.3 Consequence due to Buyer Event of Default

In the event of Buyer event of Default as per clause 15.1(b), the Buyer shall provide a revolving irrevocable Stand by Letter of Credit in the SBT Vidyuthi Bhavanam Branch, Pattom, Thiruvananthapuram, which shall be equal to 1 month bill amount which is arrived as per the provisions in Clause 9.2. The Stand by LC can be operated only in the event of default as per provisions of clause (iii) of article 15.1(b).

### 15.4 Obligations of Buyer on Termination

Buyer shall pay all undisputed outstanding dues of the Company as per the provisions of this agreement.

### 15.5 Obligations of the Company on Termination

Upon termination of this Agreement, the company shall pay all legitimate dues to the buyer.

## ARTICLE 16

### DISPUTE RESOLUTION

#### 16.1 Amicable Resolution

- (a) Save where expressly stated to the contrary in this Agreement, any dispute, shall in the first instance, be resolved amicably in accordance with the procedure set forth in clause (b) below.

  
 CHIEF ENGINEER  
 (Corporate Planning)  
 KSE Board, Vidyuthi Bhavanam  
 Pattom, Thiruvananthapuram - 4

For ASIAN STAR CO. LTD.,

  
 DIRECTOR



- (b) Either party may require such dispute to be referred to the Chairman, Kerala State Electricity Board and the Chief Executive Officer of the Company, for amicable settlement. Upon such reference, the two shall meet at the earliest mutual convenience and in any case within 15 days of such reference, to discuss and attempt to amicably resolve the dispute. If the dispute is not amicably settled within 30 (thirty) days of such meeting between the two, the dispute may be referred for adjudication by Kerala State Electricity Regulatory Commission in accordance with the provisions of the Electricity Act 2003.

## ARTICLE 17

### LIABILITY AND INDEMNITY

#### 17.1 Limitation of Liability

Except as expressly provided in this Agreement, neither the Company nor the Buyer nor their respective officers, directors, agents, employees of Affiliates (or their officers, directors, agents or employees) shall be liable or responsible to the other party or its affiliates, officers, directors, agents, employees, successors or assigns (or their respective insurers) for incidental, indirect or consequential damages, connected with or resulting from performance or non-performance of this Agreement, or anything done in connection herewith, including claims in the nature of lost revenues, income or profits (other than payments expressly required and property due under this Agreement). The Buyer shall have no recourse against any officer, director or shareholder of the Company or any affiliate of the Company or any of its officers, directors or shareholders. The Company shall have no recourse against any officer of the Buyer, or any affiliate of the Buyer or any of its officers:

Provided that under this Article, a party shall be liable to the other party for any additional costs, expenses or loss suffered, arising directly from a wilful default of the party obligations under this Agreement.

For the purposes of this Article, "wilful default" shall mean-

- i) an intentional or reckless breach / disregard by a party of its obligations under this Agreement;
- ii) a failure to remedy a breach resulting from an error of judgement or mistake arising in good faith; or
- iii) a failure to remedy a breach, in accordance with Prudent Industry Practice.

#### 17.2 Indemnification

- (a) The Buyer shall bear responsibility for loss of or damage to property, death or injury to person (or any claim against the Company and / or its contractors in respect thereof) and all expenses relating thereto (including without limitation reasonable legal fees) suffered by the Company and/or its contractors in connection with the Project resulting from any negligent act or omission of the Buyer, without recourse to the Company and / or its contractors. The Buyer shall hold the Company and / or its contractors fully indemnified in respect thereof.

  
**CHIEF ENGINEER**  
 (Corporate Planning)  
 KSE Board, Vidyuthi Bhavanam

For ASIAN STAR CO. LTD.,

  
**DIRECTOR**



The indemnity shall not extend to any loss, damage, death or injury (or any claim in respect thereof) or any expenses relating thereto to the extent that it was caused by any act or omission of the Company and / or its contractors to take reasonable steps in mitigation thereof. Provided that nothing in clause 2 (a) of this article, shall apply to any loss, damage, cost or expense in respect of which and to the extent that, the Company and / or its Contractors are compensated pursuant to the terms of any insurance, or other contracts such as the construction contract or the operation and maintenance contract.

- (b) The Company shall bear responsibility for loss of or damage to property, death or injury to person (or any claim against the Buyer and / or its contractors in respect thereof) and all expenses relating thereto (including without limitation reasonable legal fees) suffered by the Buyer in connection with the Project resulting from any negligent act or omission of the Company and / or its contractors, without recourse to the Buyer. The Company shall hold the Buyer fully indemnified in respect thereof. The said indemnity shall not extend to any loss, damage, death or injury (or any claim in respect thereof) or any expenses relating thereto to the extent that it was caused by any act or omission of the Buyer or the failure of the Buyer to take reasonable steps in mitigation thereof. Provided that nothing in this sub article of this Agreement shall apply to any loss, damage, cost or expense in respect of which and to the extent that the Buyer is compensated pursuant to the terms of any insurance, Agreement or through any other means.
- (c) In the event such injury or damage results from the joint or concurrent, or negligent or intentional acts of the parties, each shall be liable under this indemnification in proportion to its relative degree of fault.

### 17.3 Intimation of Proceedings

- (a) Where a party receives a claim from a third party in respect of which it is claimed to be indemnified under clause 2 above, it shall promptly intimate the other party of such claims.
- (b) Neither party shall settle or compromise any claim, action, suit nor proceeding with third party in respect of which it is entitled to be indemnified by the other party without the prior written consent of that party, such consent shall not be unreasonably withheld or delayed.

### 17.4 Defence of Claims

The indemnified party shall have the right to contest, defend, and litigate any claim, action, suit or proceeding by any third party alleged or asserted against such indemnified party in respect of, resulting from, related to or arising out of any matter for which it is entitled to be indemnified hereunder, and the reasonable costs and expenses thereof shall be subject to the indemnification obligations of the indemnifying party hereunder; provided, however, that if the indemnifying party acknowledges in writing its obligations to indemnify the indemnified party in respect of loss to the full extent provided by Article 17.2 of this Agreement, the indemnifying party shall be entitled, at its option to assume and control the defence of such claim, action, suit or proceeding, liabilities, payments and obligations at its expense and through counsel of its choice if it gives prompt notice of its intention to do so to the indemnified party and reimburses the indemnified party for the reasonable costs and expenses incurred by the indemnified party prior to the assumption by the indemnifying party of such defence.

  
**CHIEF ENGINEER**  
 (Corporate Planning)

**For ASIAN STAR CO. LTD.,**

  
**DIRECTOR**

The indemnified party shall not be entitled to settle or compromise any such claim, action, suit or proceeding without the prior written consent of the indemnifying party, which consent shall not be unreasonably withheld or delayed.

Further, the indemnified party shall have the right to employ its own counsel and such counsel may participate in such action, but the fees and expenses of such counsel shall be at the expense of such indemnified party, when and as incurred unless,-

- (a) the employment of counsel by such indemnified party has been authorised in writing by the indemnifying party,
- (b) the indemnified party shall have reasonably concluded that there may be a conflict of interest between the indemnifying party and the indemnified party in the conduct of the defence of such action,
- (c) the indemnifying party shall not in fact have employed independent counsel reasonably satisfactory to the indemnified party to assume the defence of such action; and shall have been so intimated by the indemnified party, or
- (d) the indemnified party shall have reasonably concluded and specifically intimated the indemnifying party either that there may be specific defences available to it which are different from or additional to those available to the indemnifying party or that such claim, action, suit or proceeding involves or could have a material adverse effect upon it beyond the scope of the Agreement.

In order to apply sub-clause (b), (c) or (d) above, the counsel for the indemnified party should have the right to direct defence of such claim, action, suit or proceeding on behalf of the indemnified party and the reasonable fees and disbursements of such counsel shall constitute legal or other expense.

#### 17.5 Assignment and Charges

No party shall assign this Agreement or the rights, benefits and obligations hereunder save and except with prior consent of the other party. Provided that the Company can create/ assign all or any of its rights and benefits under this Agreement as security for indebtedness, in favor of the Lenders and working capital providers for the Project;

### ARTICLE 18

#### MISCELLANEOUS PROVISIONS

- 18.1 Any variation, waiver or modification of any of the terms of this Agreement shall be valid only if communicated in writing and agreed and signed by / or on behalf of the parties hereto.
- 18.2 The invalidity or unenforceability for any reason of any part of this Agreement shall not prejudice or affect the validity or enforceability of the remainder.

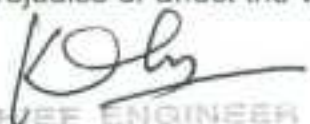
  
**CHIEF ENGINEER**  
 (Corporate Planning)  
 KSE Board, Vidyarthi Bavanam

For ASIAN STAR CO. LTD.,

  
**DIRECTOR**

Contd ..... 32



- 18.3 The failure of any party to insist in one or more instances upon the strict performance of any of the provisions of this Agreement or to take advantage of any of its rights hereunder shall not be construed as waiver of any such provision or relinquishment of any such rights but the same shall continue in full force and effect.
- 18.4 Unless the context otherwise requires, every arrangement, procedure or any other matter which is, under any of the provisions of this Agreement, required to be mutually agreed upon between the parties, shall be concluded by a written Agreement between the parties.
- 18.5 The Agreement shall not be interpreted or construed to create an association, joint venture, or partnership between the parties or to impose any partnership obligation or liability upon either party. Neither party shall have any right, power or authority to enter into any Agreement or undertaking for or act on behalf of or to act as or be an agent or representative of or to otherwise bind, the other party.
- 18.6 Cancellation, expiration or earlier termination of the Agreement shall not relieve the parties of obligations that by their nature should survive such cancellation, expiration or termination, including without limitations, warranties, remedies, promises of indemnity and confidentiality; provided, however, that all obligations surviving the cancellation, expiration or early termination of the Agreement shall only survive for a period of 5 (five) years.
- 18.7 The language of the Agreement shall be English. All documents, notices, waivers and all other communication written or otherwise between the parties in connection with the Agreement shall be in English language.
- 18.8 The Agreement and the rights and obligations hereunder shall be interpreted, construed and governed by the Laws of India, as in force, from time to time.
- 18.9 The Schedules (I to 10) and Annexure (I to VI) attached hereto are intended by the parties as the final expression of their Agreement and are intended also as a complete and exclusive statement. All prior written or oral understandings, offers or other communications of every kind pertaining to the sale or purchase of Electrical output hereunder between the Buyer and the Company are hereby abrogated and withdrawn.
- 18.10 The Agreement shall not confer any right of suit or action, whatsoever, on any third party.
- 18.11 The Company shall obtain and maintain necessary policies of insurance during the term of this agreement consistent with prudent utility practices.
- 18.12 Under no circumstance shall Buyer undertake any contingent liability by way of providing guarantee etc. for the Company for implementing the Project.

#### ARTICLE 19

#### INTIMATION

- 19.1 Any intimation or communication required to be in writing hereunder shall be given by any of the following means: registered, certified, or first class mail, telex, facsimile or telegram. Such intimation or communication shall be sent to the respective parties at their addresses listed below.

  
 CHIEF ENGINEER  
 (Corporate Planning)

MTC (M) Ltd. New Delhi, India

For ASIAN STAR CO. LTD.,

  
 DIRECTOR

Contd ..... 33



Except as expressly provided herein, any intimation shall be deemed to have been given on the seventh day of despatch. Any intimation given by first class mail shall be considered sent at the time of posting. Communications by telex, telecopy, or telegram shall be confirmed by depositing a copy of the same in the post office for transmission by registered, certified or first class mail in an envelope properly addressed as follows:

In the case of the Buyer

To  
**The Chairman / Chief Engineer (Corporate Planning)**  
 Kerala State Electricity Board,  
 Vaidyuthi Bhavanam,  
 Pattom, Thiruvananthapuram

Phone:

Fax:

E Mail:

In the case of the Company

To  
**M/s.Asian Star Company Limited,**  
 114-C, Mittal Court, Nariman Point,  
 Mumbai- 400 021

Phone: 22821886

Fax: 22043747

E Mail: <sup>V.P.M.</sup> info@asianstar.co.com

19.2 Any party may, by 15 (fifteen) days' written notice to the other, change the representative or the address to which such notices and communications are to be sent.

### 19.3 List of schedules and annexure

The following schedules and annexure shall form an integral part of the Agreement.

- Schedule 1:** Project Facilities
- Schedule 2:** Performance test procedure
- Schedule 3:** Technical Limits
- Schedule 4:** Electrical system characteristics and functional specifications
- Schedule 5:** Despatch procedure
- Schedule 6:** List of permits and clearances
- Schedule 7:** Start up power measuring procedure
- Schedule 8:** Work sheet for Annual Wind energy output
- Schedule 9:** Project site particulars
- Schedule 10:** Tariff Table
- Annexure I:** Project facility description
- Annexure II:** Certified power curve and Single line diagram
- Annexure III:** Bill meter reading
- Annexure IV:** Check meter reading
- Annexure V:** Daily generation report
- Annexure VI:** Monthly tripping report

  
**CHIEF ENGINEER**  
 (Corporate Planning)  
 KSE Board, Vaidyuthi Bhavanam  
 Pattom, Thiruvananthapuram - 4

For ASIAN STAR CO. LTD.,  
  
**DIRECTOR**

IN WITNESS WHEREOF, the Parties hereto have caused this Agreement executed on the day, month and year first above written

THE COMMON SEAL OF  
**M/S Asian Star Company Limited**, (the  
 Company) was pursuant to a resolution of its  
 Board of Directors passed 12<sup>th</sup> Feb 08 on that day  
 hereunto affixed in the presence of:

**For ASIAN STAR CO. LTD.,**

  
 DIRECTOR

SIGNED BY  
 For **M/s. Asian Star Company Limited**

**For ASIAN STAR CO. LTD.,**

  
 DIRECTOR

In the presence of witness:

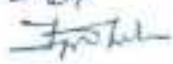
- 
1. PRANAV K. KAPADIA  
 R-302, PANCHSHEEL GARDEN  
 MAHAVIR NAGAR  
 KANDEIVALI WEST  
 MUMBAI - 67
  2.   
 ASHISH P. SHAH  
 C-44, GAUTAMI NAGAR AND  
 L.T. ROAD, BORIVALI (WEST)  
 MUMBAI - 92

SIGNED BY:

For and on behalf of the **Kerala State Electricity Board.**

  
 CHIEF ENGINEER  
 (Corporate Planning)  
 KSE Board, Vidyutha Bhavanam  
 Pattom, Thiruvananthapuram - 4

In the presence of witness,

1.

2.

**SCHEDULE 1**

(Brief provisions of the Technical proposal of the company as approved by ANERT)

**SALIENT FEATURES**

S:No	Description	Particulars
1.	<b>General Data</b>	
	1.1 Make of WEG	SUZLON
	1.2 Type	S-52
	1.3 Rated Output (KW)	600 KW
	1.4 Hub Height (m)	75 M
	1.5 Rotor diameter (m)	52 M
	1.6 No. of blades	Three (3)
	1.7 Rotor Orientation (Upwind / downwind)	Up wind
	1.8 Power Regulation	Pitch
	1.9 Pitch angle for stall regulated machine	-NA-
	1.10 Cut in wind speed (m/s)	4 m/sec
	1.11 Wind speed at rated out put (m/s)	13 m/sec
	1.12 Cut out wind speed (m/s)	25 m/sec
	1.13 Tip speed (m/s)	66 m/sec
	1.14 Survival wind speed (m/s)	42.5 m/sec (Ref.Wind)
	a) 10 minute average at Hub Height	59.5 m/sec (Surv.Wind)
	b) 2 seconds gust at hub height	24.19 rpm
	1.15 Rated rotor speed (rpm)	--
	1.16 Maximum designed rotor speed	5°
	1.17 a) Nacelle tilt angle	4.4°
	b) Angle of cone	690 V
	1.18 Voltage (V)	± 15%
	1.19 Voltage variation (%)	50 Hz
	1.20 Frequency (Hz)	-6% to +5%
	1.21 Frequency Variation (%)	560 A
	1.22 Rated current Amps	10% 2%(Voltage)
	1.23 Asymmetry Variation (%) Current	45° C
	1.24 Designated maximum temperature (0c)	-NA-
	1.25 Noise Level (dB) (also specify distance)	20 Years
	1.26 Designated life (years)	18% (for 15 m/sec)
	1.27 Designated turbulence intensity	
2	<b>Weight</b>	
	2.1 Rotor (Kg)	10.4 Ton
	2.2 Nacelle (Kg)	27.9 Ton
	2.3 Tower (Kg)	81.5 Ton
	2.4 Total (Kg)	119.6 Ton
3	<b>Gear Box</b>	
	3.1 Make	Winergy / Hansen
	3.2 Type / Model	1 Planetary / 2 Helical
	3.3 Gear ratio	1:63.6
	3.4 No of Stages	3
	3.5 Max. power transmission	660kW
	3.6 Lubrication system	Self Lubrication
	3.7 Type of Oil	Mineral
	3.8 Quantity of Oil	120 Liters
	3.9 Type of cooling	Forced oil circulation
	3.10 Weight without oil (kg)	5.4 Ton

For ASIAN STAR CO. LTD.,

V.P.J.

DIRECTOR





	<p><b>Generator</b></p> <p>4.1 Make</p> <p>4.2 Rated power output (kw) at 0.95 power factor</p> <p>4.3 Type (synchronous / Asynchronous)</p> <p>4.4 Dual speed / Variable speed</p> <p>4.5 Voltage</p> <p>4.6 Rated rpm</p> <p>4.7 Frequency (Hz)</p> <p>4.8 Current (Amps)</p> <p>4.9 No. of Poles</p> <p>4.10 Insulation class</p> <p>4.11 Protection type</p> <p>4.12 Type of cooling</p> <p>4.13 If forced coolant than</p> <p>a) Type &amp; quantity of coolant</p> <p>b) Pump rating</p> <p>c) Motor make &amp; rating</p> <p>d) No. of phase</p> <p>e) Motor duty cycle</p> <p>4.14 KVAR consumption for generator at</p> <p>- No load</p> <p>- 25% load</p> <p>- 50% load</p> <p>- 75% load</p> <p>- 100% load</p> <p>4.15 Weight (kg)</p>	<p>Siemens</p> <p>600KW</p> <p>Asynchronous</p> <p>Single Winding</p> <p>690 V</p> <p>1500 rpm</p> <p>50 Hz</p> <p>560 A</p> <p>4 Pole</p> <p>H Type</p> <p>Differential Potential Relay</p> <p>Air cooling</p> <p>-NA-</p> <p>-NA-</p> <p>-NA-</p> <p>-NA-</p> <p>-NA-</p> <p>75 KVAR - 690 V</p> <p>175 KVAR - 690V</p> <p>275 KVAR - 690V</p> <p>375 KVAR - 690 V</p> <p>475 KVAR - 690V</p> <p>4.5 Tons</p>
5	<p><b>Tower</b></p> <p>5.1 Make</p> <p>5.2 Height</p> <p>5.3 Type (Tubular / Lattice / Material)</p> <p>5.4 No. of sections</p> <p>5.5 Assembling</p> <p>5.6 Ladder type</p> <p>5.7 Safety system</p> <p>5.8 Surface treatment</p> <p>5.9 No &amp; type of landing platforms</p> <p>5.10 Type of reptile protection</p>	<p>Suzlon Towers &amp; Structures Ltd.</p> <p>73 Mtr.</p> <p>Lattice</p> <p>-NA-</p> <p>Fastened</p> <p>Vertical Climbing</p> <p>Ladder with Safety harness</p> <p>Checked plate &amp; Fall arrestor</p> <p>Hot dip Galvanised (HDG)</p>
6	<p><b>Yawing system</b></p> <p>6.1 Make &amp; Type</p> <p>6.2 Gear ratio</p> <p>6.3 Rated capacity of yaw motor (kw)</p> <p>6.4 No. of yaw motors</p> <p>6.5 Type of yaw brake</p> <p>6.6 No. of yaw brake</p>	<p>Borfiglioli</p> <p>1:2500</p> <p>1.5KW</p> <p>2 Nos.</p> <p>Electro Magnetic Type</p> <p>2 Nos</p>
7	<p><b>Brake system</b></p> <p>7.1 Aero dynamic</p> <p>- Type</p> <p>- Control</p> <p>7.2 Mechanical</p> <p>- make</p> <p>- position</p> <p>- No. of Calipers</p> <p>- Motor capacity (kw)</p>	<p>Active Pitch</p> <p>Variable frequency drive(VFD)</p> <p>Hanning &amp; Kahl</p> <p>Left</p> <p>1 Set</p> <p>0.5 HP</p>

For ASIAN STAR CO. LTD.,

  
DIRECTOR

8	<b>Rotor</b> 8.1 Blade material 8.2 No. of blades 8.3 Rotor diameter (m) 8.4 Swept area (m <sup>2</sup> ) 8.5 Length of blade (m) 8.6 Blades profile 8.7 Weight of each blade 8.8 Ref.: Standards - Ref no - Date of issue - Name of authority with address 8.9 Lighting protection for blades	Glass fiber reinforced EPOXY 3 Nos 52 Mts 2124 m <sup>2</sup> AE25 TUDELFT 1400 Kg  AERT-HOLLAND Embedded Aluminum with birded copper flat
9	<b>Hub</b> 9.1 Make and type 9.2 Material	Cast SP helical hub EN-GJS-400-18V-LT
10	<b>Main shaft</b> 10.1 Make & type 10.2 material	Shrink fit with GB EN-GJS-400-18V-LT
11	<b>Main Bearing</b> 11.1 Make 11.2 Type and specification	FAG / SKF Spherical roller bearing
12	<b>Coupling</b> 12.1 Make 12.2 Type and specification	KHR-ARC06 Apex Coupling, Constant Speed
13	<b>Nacelle</b> 13.1 Material 13.2 Type of nacelle bed 13.3 Facility of loading and unloading 13.4 Lighting protection	EN-GJS-400-18V-LT Cast box frame Hook provided Lighting attractor grounded to earth.
14	<b>Power factor compensation</b> 14.1 Capacity (KVAR) 14.2 Rated Voltage 14.3 Number 14.4 No of steps 14.5 Power factor at different loads after compensation - No load - 25% load - 50% load - 75% load - 100% load 14.6 Guaranteed KVARh consumption as Percentage of annual Kwh generation	25 KVAR x19 Nos = 475 690 V 19 Nos 8 x 2 (25 KVAR)  75 KVAR 175 KVAR 275 KVAR 375 KVAR 475 KVAR 3%
15	<b>Power Panel</b> 15.1 Voltage 15.2 Short circuit level 15.3 Rating of main MCCB 15.4 Provision for earth fault protection 15.5 Dimension 15.6 Relevant standards	690 V 15 KA - 690 V 630 A Inbuilt - MCCB 150 x 150

For ASIAN STAR CO. LTD.,

V. P. J. W.  
 DIRECTOR

16	<b>Control system</b> 16.1 Type 16.2 List of display (separate sheet attached) 16.3 List of error messages(separate sheet attached) 16.4 List of annunciation (separate sheet attached) 16.5 Stop features 16.6 Remote control facility 16.7 Printing facility 16.8 Details of special accessories (like Lap-top computer) for retrieval of parameters including power curve data.	List Enclosed List Enclosed List Enclosed List Enclosed List Enclosed Yes Yes Enclosed
17	Details of AC-DC-AC converter / Inverter system ( for variable speed WEGs)	-NA-
18	<b>Sensors</b> List of sensors ( Please attach separate sheet)	List Enclosed
19	<b>Power cable</b> Between generator & Power Panel <ul style="list-style-type: none"> <li>- Type &amp; make</li> <li>- Conductor material</li> <li>- Conductor size</li> <li>- No of core</li> <li>- Ref standard</li> </ul> Note: Please attach cable schedule for other cables giving details like purpose, type no. of cores etc.	XLPE / Rubber Copper 150 Sqm 1 core x 2 run / Phase IEC
20	<b>ISO 9000 certification</b> 20.1 Category certification 20.2 Date of certification	ISO 9001:2000 (DNV)
21	<b>Power Evacuation system and substation details.</b>	33KV feeder from Agali to Switching Yard. / 33/11KV Agali SS.( It can cater 22MW)

For ASIAN STAR CO. LTD.,



DIRECTOR

✓



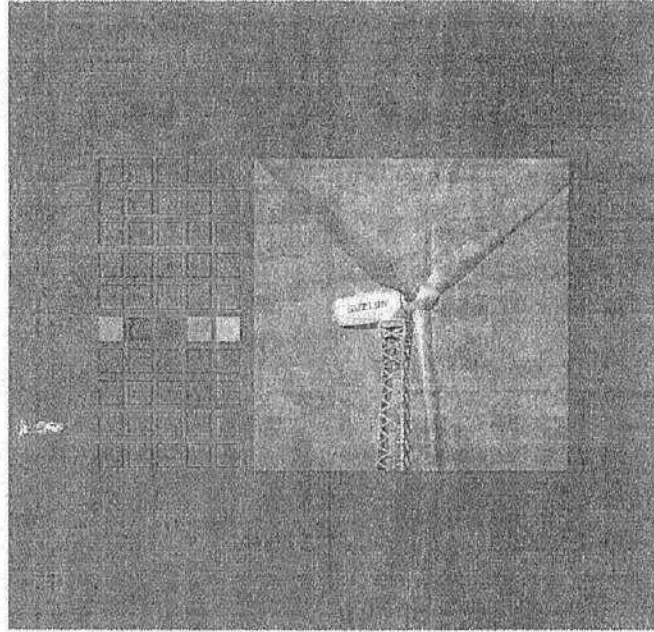

**KILOWATT SERIES 600**  
TECHNICAL SPECIFICATIONS



For ASIAN STAR CO. LTD.,

*V.P.J.*

DIRECTOR

*B*

At Suzlon, our ethos is: "We are because we innovate."

Reinforcing this philosophy is our unflinching commitment to continuously raise the bar – to provide technologically superior, more reliable, and efficient wind turbines.

The Suzlon Kilowatt series of high-performance wind energy generators is replete with such innovations:

- **Unique Micro Pitch System**

Unparalleled full span pitching from -3 to 90° with resolution of 0.1° results in maximum power harnessing and minimal losses. The system includes smart logic automated pitching and independent electromechanical pitch control for each blade.

- **State-of-the-art Manufacturing Technology**

Manufactured using the advanced Vacuum Assisted Resin Infusion Moulding (RIM), the rotor blades have a low weight-to-sweep ratio ensuring higher energy outputs at lower costs. The RIM technique results in a homogeneous structure which is light on weight and high on strength.

- **Advanced Control System**

Precisely calibrated sensors installed at each critical junction closely monitor factors like temperature, wind speeds, vibrations etc. The remote monitoring and control option enhances ease of operation.

- **High-quality Power Generation**

Suzlon turbines are soft and friendly towards the utility grid. Each component, from the blade to the grid, is designed to generate high quality and grid-friendly power with negligible harmonics.

- **Well-balanced Design**

The wind turbines are designed to withstand the toughest environmental conditions. The robust design of the WEG, with its uniform weight distribution, ensures high levels of safety, reliability and enhanced service life.



These innovative features culminate in numerous tangible benefits for our customers:

Higher efficiency / performance

Reduced stresses and loads

Better power quality

Increased safety

Prolonged life / durability

Higher reliability

Lower operative cost

Increased ROI

Peace of mind

For ASIAN STAR CO. LTD.,

*V.P.J.*

DIRECTOR

*B*

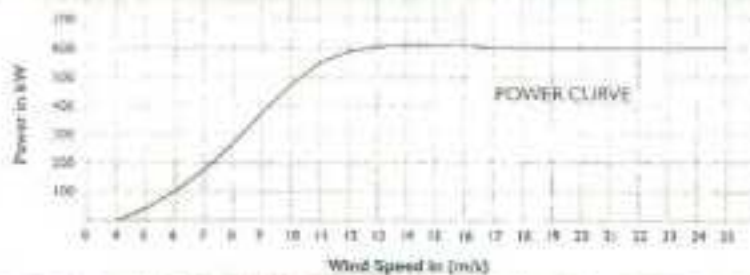

#### Rotor

Capacity	32 m
No. of blades	3
Construction	Laminated Fiberglass
Rated speed	23 rpm
Rated pitch	13.5 m/s
Material	Glass reinforced epoxy, stainless-steel
Weight	22,000 kg
Hub height	25 m
Regulator	Pitching gear

#### Operational Data

Cut-in wind speed	4 m/s
Rated wind speed	13.5 m/s
Cut-off wind speed	25 m/s

#### Gearbox

Type	2-stage planetary gear
Ratio	1:63.033
Material	Steel - Nitriding treatment
Rated input	800 kW (Mechanical power)
Type of cooling	Oil cooling system - forced circulation

#### Generator

Type	Single speed induction generator
Rated output power	1.5 MW
Rated output	400 V/3
Rated voltage	480 V
Frequency	50 Hz
Insulation	Class F
Overload class	F-1.5
Cooling system	Air cooled

#### Operating Brakes

Asynchronous motor	1 (resistor system with brake chopper)
--------------------	--

#### Yaw Drive

Yaw drive motor	3 phase electrical motor
Yaw drive gear	Planetary gear bearing

#### Control Unit

Microprocessor based rotating controller location. Control valves, turbine switchgear, monitoring, log with real time local access and logging function. Options include monitoring & operation, UPS back up system.

#### Relative Control Comparison

Conversion	Hydraulic & electrical with gear ratio 0.5
------------	--

#### Safety Systems

Brake system	Automatic operation by independent system with electrical control of the brake pitching in case of: <ul style="list-style-type: none"> <li>• Violation of rated loading</li> <li>• Excess temperature of the generator or generator failure of the generator in case of wind speed in excess of 25 m/s</li> <li>• Violation of the rated voltage range</li> <li>• Violation in the frequency range</li> <li>• Asymmetric pitching</li> <li>• Low temperature with lubricant oil viscosity</li> </ul>
--------------	--

#### Tower

Type	Free standing, lattice tower, fully guyed
Tower height	24.250 m
Capacity	Substation, control, storage & etc.
Construction	Steel tower
Usage	1: 100% &



For ASIAN STAR CO. LTD.,

*V. P. J.*  
DIRECTOR

*K*



R & D Reebok	<b>OPERATION MANUAL SUZLON S52</b>	 SUZLON
-----------------	--	---

#### 4 Safety reminders

The following safety reminders have to be observed for the control and operation of the wind turbine:

1. Please read this manual carefully before operating the wind turbine.
2. The wind turbine is fitted with four emergency stop buttons. The pushbuttons are marked with the usual international symbols. If one of the emergency stop buttons is pressed, the wind turbine will be de-energised and the blades pitch back into feathering position. When the emergency stop buttons in the nacelle is pressed additional to the pitch the rotor brake will be released to bring the system to total stop position.

**Please familiarise with the position of the emergency stop buttons prior to starting the wind turbine!**

The emergency stop buttons are located:

- In the tower base on the front panel of the control cabinet (bottom cabinet).
- In the tower base on the front panel of the compensation cabinet (bottom cabinet).
- At the yaw platform near the tower hatch
- In the nacelle on the front panel of the control cabinet (top cabinet).

3. Before climbing a wind turbine make yourself familiar with the safety equipment and follow the national safety guidelines.

Do not climb up the wind turbine without using the complete safety equipment fitting the fall protection system, as well as helmet, gloves and solid shoes. A securing rail where the slider is suspended and connected with the body harness is arranged in the middle of the ladder. This slider follows in the securing rail during the climb and descent. Several platforms, which are accessible via hatches, are provided in the tower. After having passed the hatch, close the hatch covers in order to prevent any hazard to persons following you due to parts falling down.

**It is absolutely necessary to use the safety equipment! The climb in the wind turbine without safety equipment may have fatal consequences!**

The slider connects you with the securing rail and stops you in the event of a fall.

**It is absolutely necessary to use the slider! The climb in the wind turbine without using the slider as prescribed may have fatal consequences!**

4. Always wear a safety belt and protect yourself with at least one of the two securing lines fitted to the body harness when staying on the nacelle or in the hub. Never loosen both securing lines simultaneously. The spring catches of the securing lines must always be secured by means of the self-locking bolt.
5. When working on the nacelle roof, please protect yourself with the securing lines fitted to the body harness. Never loosen both securing lines simultaneously. The spring catches of the securing lines must always be secured by means of the self-locking bolts.

**Any unsecured stay outside the nacelle may have fatal consequences!**

Revision	Prepared	Approved	Released	Filename	Security-code	
1.0 17.02.06	AME 06.02.06	WCO 17.02.06	WCO 17.02.06	operation manual_S52_v01.0	11	5/26

For ASIAN STAR CO. LTD.

*K*

*V. P. J.*  
DIRECTOR

R & D Rostock	<b>OPERATION MANUAL SUZLON S52</b>	 <b>SUZLON</b>
------------------	--	--

6. Before climbing up the wind turbine, please make sure that no thunderstorm is coming up or already in the sky. If you notice a thunderstorm while you are working in or on the nacelle or hub, leave the wind turbine immediately.

**Any stay in or on the wind turbine during a thunderstorm may have fatal consequences!**

7. When work is performed in or on the nacelle or in the hub, and particularly as long as the crane hatch is open, no one is allowed to stay in the danger zone under the wind turbine in order to avoid injuries due to parts or tools falling down. Also please bear in mind that parts falling down can be carried far away by the wind. In addition to these safety measures, everyone within a range of 200 meters around the wind turbine should wear a safety helmet.

8. Before entering the hub, the rotor must be secured by means of the rotor lock. Access to the hub is only allowed at wind speeds not exceeding 10 m/s. If the wind speed increases to 10 m/s and more, you must leave the hub immediately and properly unlock the rotor.

**A danger of life exists if this instruction is not observed!**

9. Only trained electricians are allowed to operate the electrical equipment and carry out repairs. This is the only way to ensure that the relevant directives and regulations are complied with.

10. The wind turbine shall not be operated when the doors of the control cabinet are open and covers are removed, as otherwise the electromagnetic compatibility is not ensured. Beyond this, a danger of life exists if non-insulated live parts are touched.

11. Please ensure that the danger warnings in the tower and on the control cabinets are observed and attached in a well visible place.

12. Operation of the wind turbine is prohibited when ice has built up on the blades.

**Ice falling down is life threatening!**

13. If problems or irregularities occur during operation of the wind turbine, please contact the responsible service centre or:

**SUZLON Energy Ltd.  
Operation & Maintenance Department  
Tel.: +91-20-4022000  
Fax.: +91-20-4022100**

Revision	Prepared	Approved	Released	Filename	Security-code	
1.0	AME	WCO	WCO	operation manual_s52-rev1.0	3b	6/26
17.02.06	06.02.06	17.02.06	17.02.06			

For **ASIAN STAR CO. LTD.**,

*V. P. J.*

**DIRECTOR**

R & D Rostock	<b>OPERATION MANUAL</b> <b>SUZLON S52</b>	 <b>SUZLON</b>
------------------	--	--

## 6 Introduction to the wind turbine's mode of operation

For the successful operation of the control, it is necessary to understand the operating mode of the wind turbine. For this purpose, you will find some explanations here. Moreover, please read chapter 10 carefully. It describes the individual operating statuses of the turbine.

As the SUZLON S52 is equipped with an asynchronous generator with high slip, it can operate within a limited speed range. In conjunction with the pitch system it is possible to achieve an optimal energy yield within a wide wind range, with comparably low loads.

Once the starting speed is reached, the turbine speed is so controlled by the pitch system that it comes as close as possible to the synchronous speed of the generator. The generator is connected to the grid by means of a soft starter with thyristors. To accomplish this, no motor start is required. In case of slow and mean wind speeds, the blades are positioned at an optimal angle of attack in order to achieve an optimal yield.

Once the nominal speed has been reached (cut-in completed; bypass contactor closed), the pitch system starts operating in order to maintain the rated power. The slip of the generator is big enough to react to minimize the load during wind gusts. Thus ensures a constant output power.

## 7 Features of the control

The turbine is controlled by SCS (SUZLON CONTROL SYSTEM) a controller hardware also called PLC (Programmable Logic Controller) and the in house designed control software. The control offers the following features and/or possibilities:

- Achievement of the maximum energy yield within all wind ranges and a constantly optimal operation of the wind turbine.
- Fault monitoring and indication via remote data transmission.
- Information as to the status and active operating conditions of the system via remote data transmission.
- Easy operation and maintenance of the wind turbine.

The control is extremely robust in order to operate under the stringent environmental conditions when used in a wind turbine. Under these conditions, all standard solutions would very quickly reach their limits. The controller has therefore especially been developed for use in SUZLON wind turbines.

The control gathers information as to the actual operating conditions of the wind turbine via several sensors, for instance wind speed and direction, output power, speed and a wide range of temperatures. This data is processed in the controller and the optimal settings for the operation of the turbine are determined on the basis of the results.

Further sensors sense the grid conditions and asymmetries, so that grid failures are immediately identified and the wind turbine can be protected accordingly.

As anemometers and wind vane are provided on the nacelle roof, the rotor and the nacelle exert an influence on the measurement of the wind speed and direction. This influence is, however, known and will be balanced by the controller, so that it is possible to work with this data without any problems. In order to prepare an exact power curve of the wind turbine, it is, how-

Revision	Prepared	Approved	Released	Filename	Security-	
1.0	AME	WCO	WCO	operation manual_s52 rev1.0	code	8/26
17.02.06	06.02.06	17.02.06	17.02.06		3x	

For ASIAN STAR CO. LTD.,



DIRECTOR





R & D Hastock	<b>OPERATION MANUAL SUZLON S52</b>	 SUZLON
------------------	--	---

ever, necessary to install a wind measuring device in the undisturbed area in main wind direction before the turbine.

The actual operating data is indicated on a colour LCD display. In addition, measured values, unit values and error messages can be displayed. Keypads facilitate the operation of the control.

The SUZLON S52 wind turbine is equipped with a remote data transmission that allows for the connection of a PC.

Revision	Prepared	Approved	Released	Filename	Security	
1.0 17.02.06	AMS 06.02.06	WCD 17.02.06	WCD 17.02.06	operation manual_s52-rev1.0	code 3b	9/26

**FRASER STAR CO. LTD.**

  
**DIRECTOR  
DIRECTOR**

R & D Risibick	OPERATION MANUAL SUZLON S52	
-------------------	--------------------------------	---

## 12 Error messages and troubleshooting

### 12.1 Status codes – alarms and warnings

There are two types of errors:

- **System errors / alarms:** The wind turbine is stopped. A specific brake program is stored for each error. The wind turbine can only be started after elimination of the cause of alarm and acknowledgement of the alarm. Some of the alarms are reset automatically once the cause of it does no longer exist, e.g. line faults.
- **Warnings:** The wind turbine continues to operate but any irregularity during operation is signalled. The service should watch this closer on the next occasion. These statuses are not critical. It is only when this irregularity occurs several times that an alarm is set off, which causes the wind turbine to stop.

A status code is assigned to each error. If an error occurs in the system, the control transmits the corresponding status code to the service centre provided a communication line for remote data transmission exists.

Provided the error has been eliminated and the operator has an access right that is equal to or higher than the required level, then the status code can be reset.

Revision	Prepared	Approved	Released	Filename	Security-code	
1.0 17.02.08	AME 08.02.08	WCO 17.02.08	WCO 17.02.08	operation manual_s52 rev1.0	7b	23/26

For ASIAN STAR CO. LTD.,

  
DIRECTOR

R & D Restock	<b>OPERATION MANUAL SUZLON S52</b>	 SUZLON
------------------	--	---

## 12.2 Help for troubleshooting

The following table contains some of the errors that may occur during operation and their causes. If problems arise, which are not mentioned here, please contact the service hotline below unless such problems are just being solved via remote access.

### Service Hotline:

**SUZLON Energy Ltd.**  
**Operation & Maintenance Department**  
**Tel.: +91-20-4022000**  
**Fax.: +91-20-4022100**

Problem	Possible cause	Elimination
The operator cannot log in	Another person with a higher access right has already logged in.	Login is only possible after the operator with the higher access right has logged out.
The display is dark	No voltage supply	Verify whether there is a mains failure. After approximately 3 minutes the battery buffer is empty so that the control is inactive. Once voltage is available again, the system reboots and can be operated.
The wind turbine does not start.	A fault has occurred.	The existing access right is insufficient to acknowledge the error.  The elimination of the cause of error requires skilled personnel.
	The operator has no active status	Log in and obtain your access right.
No manual yaw possible	A fault has occurred and blocks the yaw motion	The elimination of the cause of error requires skilled personnel.
The wind turbine does not start but is yawing	The wind has shifted, and before starting, the turbine first carries out a yaw motion.	Please wait.
	The cables must be unwinded.	Please wait.
The blades are moved back and forth but the turbine does not correctly start.	The control conducts some system tests, which are prescribed after a certain number of operating hours.	Please wait.

Revision 1.0 17.02.06	Prepared ANE 06.02.06	Approved WCO 17.02.06	Released WCO 17.02.06	Filename operation manual_s52-rev1.0	Security code 3b	24/26
-----------------------------	-----------------------------	-----------------------------	-----------------------------	---	------------------------	-------

For ASIAN STAR CO. LTD.,

*k*

*V. P. S.*  
DIRECTOR



**List of Sensors for 600KW WEG**

1. Vibration Sensor
2. Proximity Switch ( Rotor Speed)
3. Proximity Switch ( Generator Speed)
4. Yaw Sensor
5. Infra-red Sensor
6. Twist Stop Sensor
7. EOC
8. Anemometer
9. Wind vane
10. Pressure Switch
11. Hygrostat
12. Break ON/OFF Sensor
13. Pad wear Sensor

**For ASIAN STAR CO. LTD.,**



**DIRECTOR**

**SCHEDULE 2**  
**PERFORMANCE TEST PROCEDURE**

2.1. Before initial synchronization, not later than fifty (50) days before the Date of Completion, the Company shall supply the following documents to the Buyer for approval:

- a) Final single line electric diagram of the Project; (Enclosed)
- b) Electrical protection study report; (Enclosed)
- c) Start-up procedure and on-grid testing program; and
- d) Operating procedure and other Agreements as described in article 8.2

2.2 Before conducting performance test, the Company shall supply the following documents to the Buyer for approval:

- a) Report of completion of on-grid testing program
- b) Copies of insurance policies covering the Project

2.3 The Company shall give a seven (7) days notice to the Buyer/authorized agency before starting the Performance Test. The Buyer/authorized agency may depute an Engineer to witness the Performance Test.

2.4 Scope of Performance Test.

i) During each Performance Test, the Project shall be operated in a manner similar to normal Commercial operation with all auxiliary loads and losses associated.

(ii) The Performance Test will be considered successful if the Project operates for a period of fourteen days with a minimum of one day's continuous operation at or above 90% of its Nominal Capacity of operation within the Technical Limits specified in Schedule 3.

2.5 Test Report

The Test Report shall include the following:-

- (i) Kilowatt-hour, kvarh and kilo-Watt meter readings at interconnection point to verify the net output. Reproduced copies of actual log sheets are preferred wherever possible.
- (ii) For wind turbine unit(s), a curve of net capability, with test result noted on the graph.
- (iii) Calculation of Tested Capacity inclusive of notes explaining reason for any failure to achieve Nominal Capacity, and intended date and means of correcting the deficiency or re-rating the unit capability.
- (iv) Test Report and settings of all relays should be intimated to the Buyer before Commercial Operation

**For ASIAN STAR CO. LTD.,**



  
**DIRECTOR**

**SCHEDULE 3****TECHNICAL LIMITS**

1	Type of Turbine	:	Suzlon, S-52
2.	Generation Voltage Nominal	:	690 Volts
3.	Power factor	:	0.95 lag
4	Frequency Range	:	49 Hz to 50.0 Hz
5	Nominal Grid frequency	:	50 Hz
6	Grid Voltage	:	33KV
7	Load Variation during normal Operation	:	5% to 15% ( Based on wind velocity)

**Note:**

1. Even though normal regime of operation shall be 85 % to 100% the Company shall operate the Project at a lower load when so required by the SLDC with in guarantee terms as specified by Machine supplier.
2. Each unit shall be capable of generating and delivering reactive power corresponding to a pf as specified in item(3) above
3. Operation of the project outside the nominal voltage with +10% to -10% variation and pf range as specified above will result in a reduction of pf output consistent with generator capability curves which results in penal charges.



For **ASIAN STAR CO. LTD.,**



**DIRECTOR**



SCHEDULE 4ELECTRICAL SYSTEM CHARACTERISTICS AND FUNCTIONAL SPECIFICATIONS

1. Generator Terminal Voltage : 690 volts
2. Frequency : 50Hz
3. Speed at rated power : 1539 RPM
4. Power Factor : 0.95 lag
5. Certified power curve : Refer Annexure II (Enclosed)
6. Rated Out put : 0.60 MW, 0.63 MVA
9. Single line diagram : Refer Annexure II (Enclosed)
10. Type of Exciter : Not applicable
11. Exciter Voltage : Not applicable
12. Exciter : Not applicable
13. Automatic Voltage Regulator details : Not applicable
14. Possibility of running the Machine as Synchronous Condenser : Not applicable
15. KVAR that can be supplied : Not applicable

For ASIAN STAR CO. LTD.,

  
DIRECTOR

**SCHEDULE 5**

**DESPATCH PROCEDURE**

**S.5.1 Despatch Procedures and Availability Declarations**

Despatch of the Project shall be controlled by the State Load Despatch Centre. The SLDC shall identify and notify the company regarding the appropriate body and the names of the designated officers for the despatch of the Project at least one month prior to the Date of Completion to the first Generating Unit. Within one week of receipt of such notification the Company shall notify the names of its designated officers to receive the despatch instructions

The nominated executives will despatch the Unit(s) in accordance with this schedule. A despatch instruction can either be conveyed orally or in writing (by fax or otherwise) provided that each oral despatch instruction shall have to be confirmed in writing within 8 (Eight) hours. The receipt of any despatch instruction shall be acknowledged by the designated officers of the Company within one hour of receipt of the same.

**S.5.2 Despatch Rights**

- i) In despatching the Project, the Company shall follow the directives of the SLDC to back down generation and to resume generation of Net Electrical Energy in each case consistent with the Project's Technical Limits, Prudent Utility Practices, the recommendations of the manufacturers of major equipment, this Agreement and other arrangements between the Company and the SLDC regarding communication and co-ordination of operation (each such directive being called a "Despatch Instruction).

**S.5.3 Availability Declarations**

Generally as soon as practicable before the Commercial Operation of the Generating Unit (or of the last Generating Unit, if there is more than one Generating Unit) and from time to time thereafter, but not later than the Prescribed Time each day, the Company shall deliver to the SLDC an Availability Declaration including the following information:-

- (i) The date of time that such Availability Declaration is issued;
- (ii) The period to which such Availability declaration relates; and
- (iii) Changes:

Provided that the Company shall take reasonable care in preparing Availability Declarations with a view towards declaring accurately the company's expectations regarding the performance of the Generating Unit(s) and each Generating Unit in accordance with this Agreement.



**For ASIAN STAR CO. LTD.,**



**DIRECTOR**

Provided further that if the Company becomes aware of any circumstance (other than a change in ambient conditions) that would be the Declared Capacity for any Settlement Period, the Company shall promptly issue a revised Availability Declaration. The Company shall change the Availability Declaration at least eight (8) hours prior to the time such changes is to become effective.

For ASIAN STAR CO. LTD.,

*V. P. M.*

DIRECTOR

*12*



**SCHEDULE 6****List of Permits and Clearances**

Statutory permits and clearances or otherwise as required for execution and operation of Wind Projects.

In general the following clearances / pre requisites are required before execution of wind projects.

- a) Technical approval by ANERT
- b) Signing of PPA with Kerala State Electricity Board
- c) Land acquisition, outright Purchase of private land
- d) Approval from State forest Department / Ministry of environment and forest if required.
- e) Clearance from the Kerala State Pollution Control Board, If required
- f) Interconnection Permission from Kerala State Electricity Board
- g) Any other clearances as may be required by central / State government / local bodies for the execution of this projects.



For ASIAN STAR CO. LTD.,



DIRECTOR

SCHEDULE 7START-UP POWER MEASURING PROCEDURE

Energy required for starting the generation from the Project shall be drawn through Buyer's transmission system and shall be measured by energy meter provided at "Interconnection Point". The units of such energy drawn from Buyer's transmission system during any billing period shall be deducted from the energy delivered by Company to the Buyer in the same billing period. The bills shall be prepared on net energy basis.

R  
FOMABIAN STAR CO. LTD.✓✓✓  
DIRECTOR  
DIRECTOR

**SCHEDULE 8****WORK SHEET FOR ESTIMATED ANNUAL WIND ENERGY OUTPUT**

Class Interval	Mid Wind Speed	Frequency percent	Total Hours	Wind Sped at 65 mtr height	Wind Speed at hub height of 75 mtr	Power output at Std Air Density	Power output at Site Air Density	Total Units Generated
				mtr/sec	mtr/sec	kW	kW	kWh
0-0	0.0	6.3	548.83	0.0	0.00	0.00	0.00	0
0.5-1.5	1.0	3.9	337.67	1.0	1.02	0.00	0.00	0
1.5-2.5	2.0	4.1	358.08	2.0	2.04	0.00	0.00	0
2.5-3.5	3.0	8.3	726.58	3.0	3.07	0.00	0.00	0
3.5-4.5	4.0	11.8	1,033.08	4.0	4.09	0.00	0.00	0
4.5-5.5	5.0	10.1	888.67	5.0	5.11	40.81	33.80	30,035
5.5-6.5	6.0	7.5	655.67	6.0	6.13	106.43	92.90	60,909
6.5-7.5	7.0	6.5	573.17	7.0	7.15	187.79	188.22	96,417
7.5-8.5	8.0	6.1	534.58	8.0	8.17	286.98	259.71	138,839
8.5-9.5	9.0	5.1	449.92	9.0	9.20	391.66	359.29	161,649
9.5-10.5	10.0	4.3	372.92	10.0	10.22	487.69	454.69	169,562
10.5-11.5	11.0	4.2	365.00	11.0	11.24	555.10	529.62	193,311
11.5-12.5	12.0	4.4	387.33	12.0	12.26	587.91	574.38	222,476
12.5-13.5	13.0	4.8	419.17	13.0	13.28	602.64	596.06	249,848
13.5-14.5	14.0	4.3	374.50	14.0	14.30	608.05	605.45	226,740
14.5-15.5	15.0	3.2	284.42	15.0	15.33	607.55	607.80	172,870
15.5-16.5	16.0	2.1	182.33	16.0	16.35	609.91	608.61	110,970
16.5-17.5	17.0	1.3	111.25	17.0	17.37	609.91	609.91	67,853
17.5-18.5	18.0	0.7	60.50	18.0	18.39	609.91	609.91	36,900
18.5-19.5	19.0	0.4	36.75	19.0	19.41	609.91	609.91	22,414
19.5-20.5	20.0	0.2	21.83	20.0	20.43	609.91	609.91	13,316
20.5-21.5	21.0	0.2	15.58	21.0	21.46	609.91	609.91	9,504
21.5-22.5	22.0	0.1	11.08	22.0	22.48	609.91	609.91	6,760

For ASIAN STAR CO. LTD.

  
 DIRECTOR



22.5- 23.5	23.0	0.1	6.33	23.0	23.50	609.91	609.91	3,863
23.5- 24.5	24.0	0.0	2.92	24.0	24.52	609.91	609.91	1,779
>>25	25.0	0.0	2.00	25.0	25.54	0.00	0.00	0
<b>Total</b>		<b>100</b>	<b>8,760</b>	<b>Gross Generation At Site Air Density (kWh) :</b>				<b>1,996,013</b>

Date of consideration

Power Law index- 0.15

Correction factor for air density

Array efficiency - 90%

Machine availability - 92%

Grid Availability - 92%

Minimum Annual energy output after correction factors per WTG- 15,20,483

Minimum Annual energy output from generation units/project as the case may be- 15,00,000 After correction factors and auxiliary consumption-

*h*

For ASIAN STAR CO. LTD.,  
  
 DIRECTOR

**Schedule 9****Project Site Particulars.**

PROFORMA TO BE SUBMITTED ALONGWITH THE APPLICATION FOR THE  
WIND POWER GENERATION:

- |   |  |
|---|--|
| 1. DETAILS OF THE APPLICANTS.           | <b>M/s.Asian Star Company Limited,</b><br>114-C, Mittal Court,<br>Nariman Point,<br>Mumbai – 400 021 |
| 2. DETAILS FOR THE PROJECT :-           |  |
| i) LOCATION                             | : KER – 223  |
| a. S.F.NO                               | : 524 (P)  |
| b. REVENUE VILLAGE                      | : Kottathara   |
| c. TALUK                                | : Mannarkkad   |
| d. DISTRICT                             | : Palakkad   |
| ii) WIND RESOURCES DATA:-               |  |
| a. NEAREST WINDMAST                     | : Nallasinga   |
| b. ANNUAL MEAN WIND SPEED.              | : 6.36 MTRS / SEC  |
| ii) UNIT SIZE OF THE WEG.<br>PROPOSED   | : 1 No. x 600KW  |
| iii) MAKE OF THE WTG                    | : SUZLON S-52/600KW.   |
| iv) LAND REQUIREMENT AND<br>PROCUREMENT | : COPY OF ANERT Report   |
| v) GRID INTER FACE ARRANGEMENT          | : THROUGH K.S.E.B.   |
| vi) COST OF THE W E G                   | : 370 LAKHS  |
| 3. TOTAL COST OF THE PROJECT            | : 370 LAKHS  |
| 4. MODE OF FINANCE                      | : 75 % TERM LOAN FROM BANK   |

**For ASIAN STAR CO. LTD.,**

*V.P.M.*  
**DIRECTOR**

5. ANNUAL ENERGY OUTPUT	:	
i) ESTIMATED ENERGY / ANNUM /MACHINE	:	15 LAKHS KWH/YEAR
ii) CAPACITOR FACTOR	:	28.50 %
iii) AVAILABILITY FACTOR	:	95 %
6. UTILITY OF ENERGY GENERATED:-		
a. HT. SC. NO.	:	NO
ii) WHETHER TO BE SOLD TO KSEB	:	YES
7. EXPECTED DATE OF COMMISSIONING	:	31.3.2008
8. DETAILS OF CENTRAL AND STATE PROMOTIONAL / FISCAL INCENTIVES SOUGHT TO BE AVAILED	:	NIL.
i) 100% ACCELERATED DEPRECIATION	:	NO
ii) CUSTOMS DUTY CONCESSION	:	N A
iii) EXCISE DUTY CONCESSION	:	N A
9. GRID CONNECTION		
i) NEAREST SUB STATION OF KSEB	:	Agali SS
ii) VOLTAGE RATIO OF THE SUBSTATION	:	33 KV
iii) DISTANCE BETWEEN THE BOARD'S SUBSTATION AND THE WIND MILL	:	13 KMS (APPROX)
iv) VOLTAGE AT WHICH GRID CONNECTION IS PROPOSED	:	33 KV Feeder
v) DISTANCE FROM THE STEP UP TRANSFORMER TO THE NEAREST GRID LINE OF THE KSEB	:	1.5 KMs
vi) SIZE OF THE CABLE PROPOSED TO BE USED	:	7/4.72 SQ MM.

For ASIAN STAR CO. LTD.,



DIRECTOR





**SCHEDULE 10****TARIFF TABLE**

year	1	2	3	4	5	6	7	8	9	10	11	12	13	14	15	16	17	18	19	20
Tariff (Rs/ Kwh)	3.14	3.14	3.14	3.14	3.14	3.14	3.14	3.14	3.14	3.14	3.14	3.14	3.14	3.14	3.14	3.14	3.14	3.14	3.14	3.14

For ASIAN STAR CO. LTD.,  
Vijay  
DIRECTOR

✓

**Annexure I****PROJECT FACILITY DESCRIPTION**

The facility consists of 1 X 600 KW installed capacity (KER-223, SUZLON, S-52) wind turbine. This wind turbine is connected to the next by a 33KV tie line. Wind turbines each spaced approximately 420 meter from the next.

(Further describe the facility) (Enclosed)

(Describe Interconnection facilities) - (Line approval)

The following site map indicates the location and layout of the Wind turbines. The following diagram shows that the location of metering devices and other equipment installed at the project substation and pooling substation.



For ASIAN STAR CO. LTD.,



DIRECTOR

**KERALA STATE ELECTRICITY BOARD**

**Proceedings of the Executive Engineer, Transmission Division, Palakkad – 20**

Sub: - Evacuation of power generated by the Wind Mills at Agali -- route approval for the 33kV line constructed by M/s.Suzlon Energy Ltd.-reg:-

Ref: Letter No. SISL/Proj/KER-Agali/006 dated 17.9.07

Order No: DB/TDP/Approval/07-08/ 688

Dt. 25.9.07

Vide Letter cited under reference, M/s.Suzlon Energy Ltd. has submitted the detailed drawing of the proposed route of 33kV line to be drawn for evacuating the power generated by the WEGs, the constructional details of poles and DPs, the pole war schedule and the VR-calculation chart. The regulation attained is 4.85% and is well within the prescribed limit. The route along with the other details is therefore generally approved subject to the following conditions.

1. Twin poles should be used in public places, main road sides, cut roads and in all other places not possessed by M/s.Suzlon.
2. There should be compulsorily a cut point after every 5<sup>th</sup> span using either twin pole or DP as per the site conditions in the area possessed by M/s.Suzlon. However the total span length of all the five individual spans should not exceed 200m. In all other places such as main road sides, cut roads and other public places all the poles should be either twin pole or DP as per necessity.



3. The maximum allowed span length should be 45m in the area possessed by M/s.Suzlon and in all other places it should not exceed 35m at any cost.

The approval has been entered in the register for sanctioned drawings and equipments as TDP 3/07-08/24.09.07

Yours Faithfully,

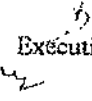
  
Executive Engineer

To  
M/s. Suzlon Energy, ✓  
Annasalai,  
Chennai.

Copy submitted to: The Deputy Chief Engineer, Transmission Circle, Palakkad.

The approval has been given from this office considering the exigency and as per your oral direction. My action in this regard may please be ratified.

Copy to: The Asst. Executive Engineer, Transmission Sub Division, Mannarkkad.  
The Asst. Engineer, 110 kV Substation, Mannarkkad.

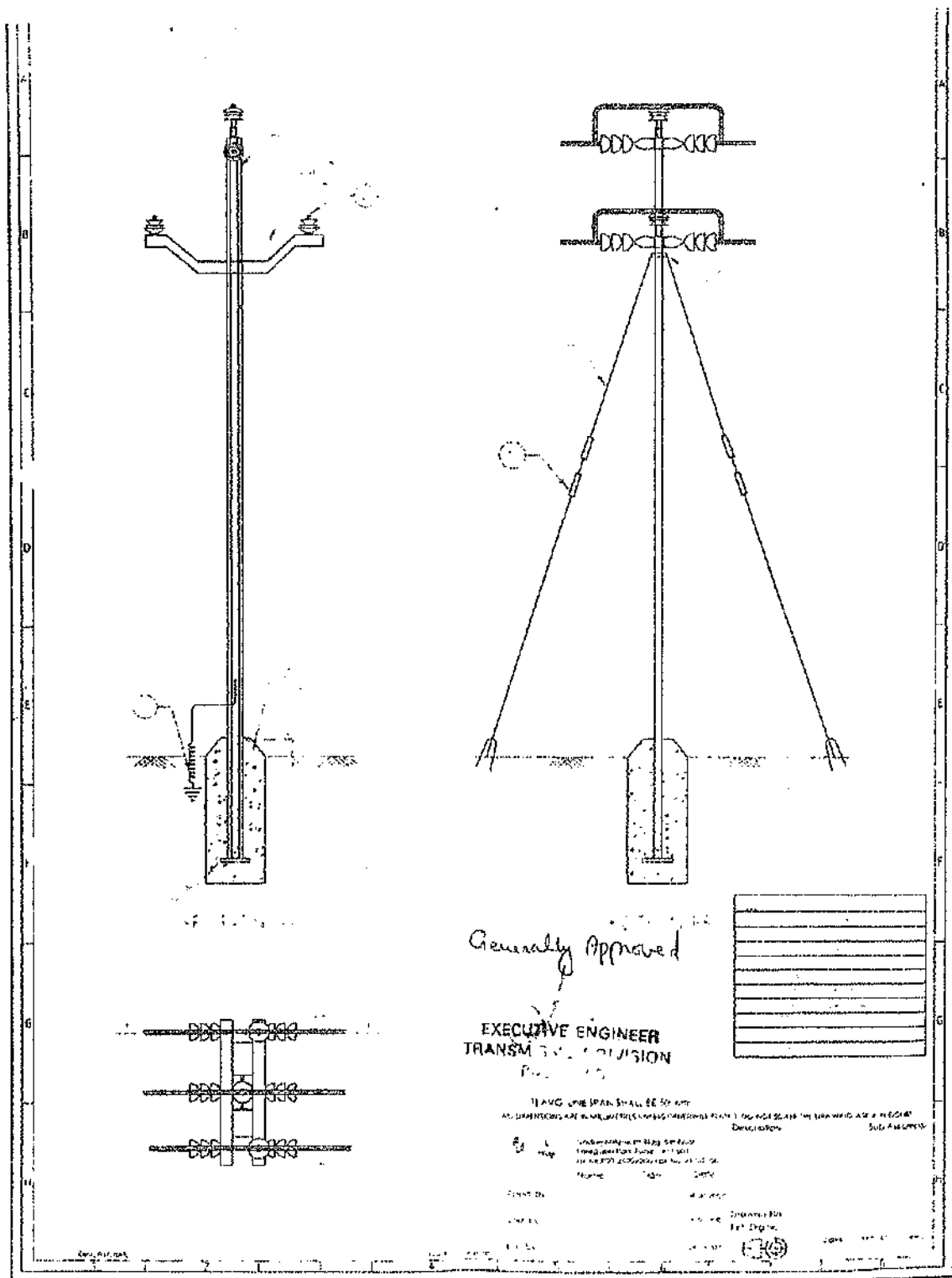

Generally Approved

**EXECUTIVE ENGINEER**  
**TRANSMISSION DIVISION**

11 AVG LINE SPAN SHALL BE 50 FT  
ALL DIMENSIONS ARE IN METERS UNLESS OTHERWISE STATED TO THE CONTRARY

No.	Description	Quantity	Unit

DATE: 11/15/54  
DRAWN BY: [Signature]  
CHECKED BY: [Signature]  
APPROVED BY: [Signature]

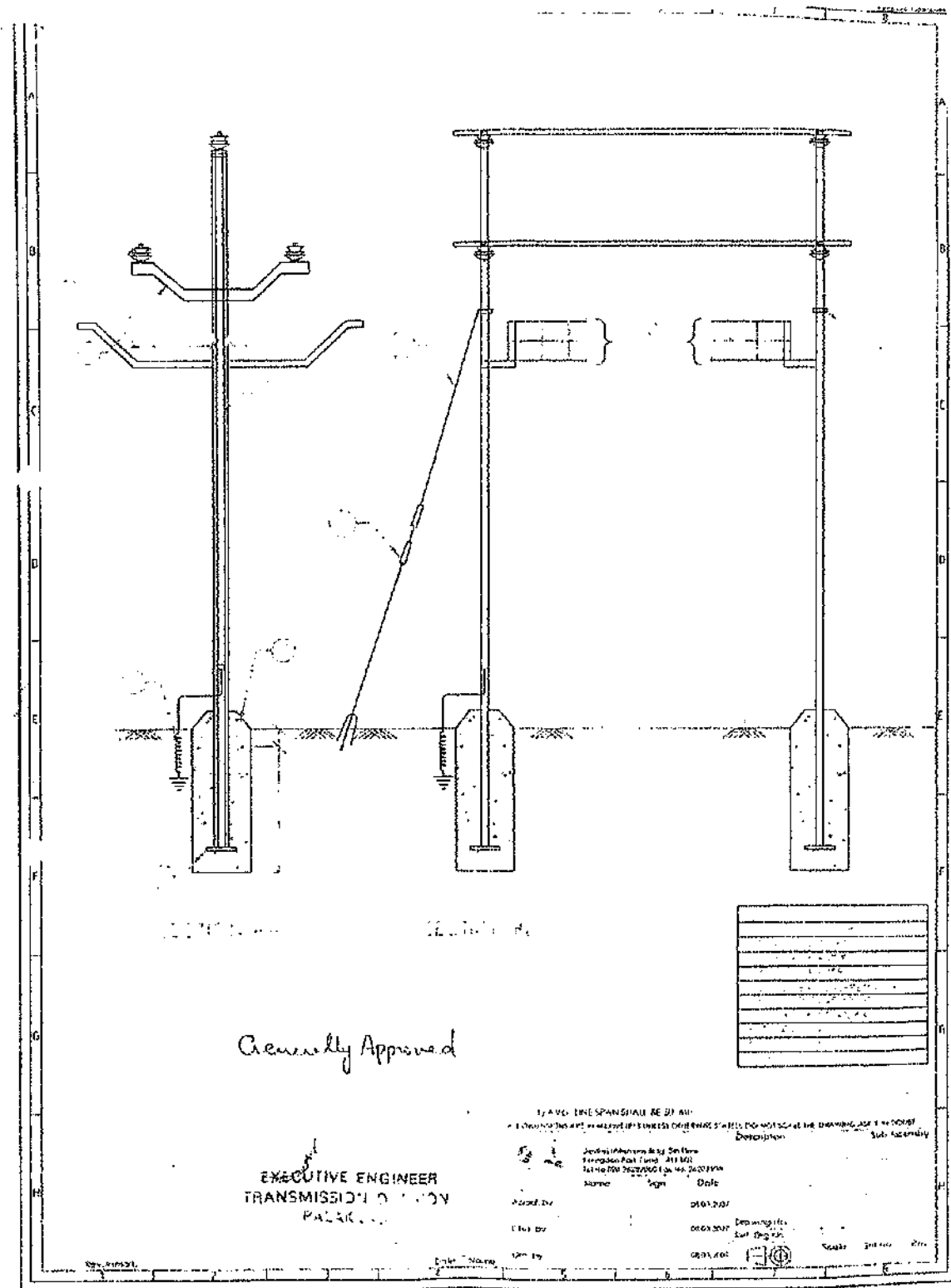

Generally Approved

EXECUTIVE ENGINEER  
TRANSMISSION DIVISION  
P.A.S.C.

1. ALL DIMENSIONS SHALL BE IN INCHES  
 2. UNLESS OTHERWISE SPECIFIED, ALL DIMENSIONS SHALL BE TO THE CENTERLINE OF THE MEMBER UNLESS OTHERWISE SPECIFIED

Name	Sign	Date	Description	Sub-Assembly
Checked by		01/01/01		
Drawn by		01/01/01		
Scale				

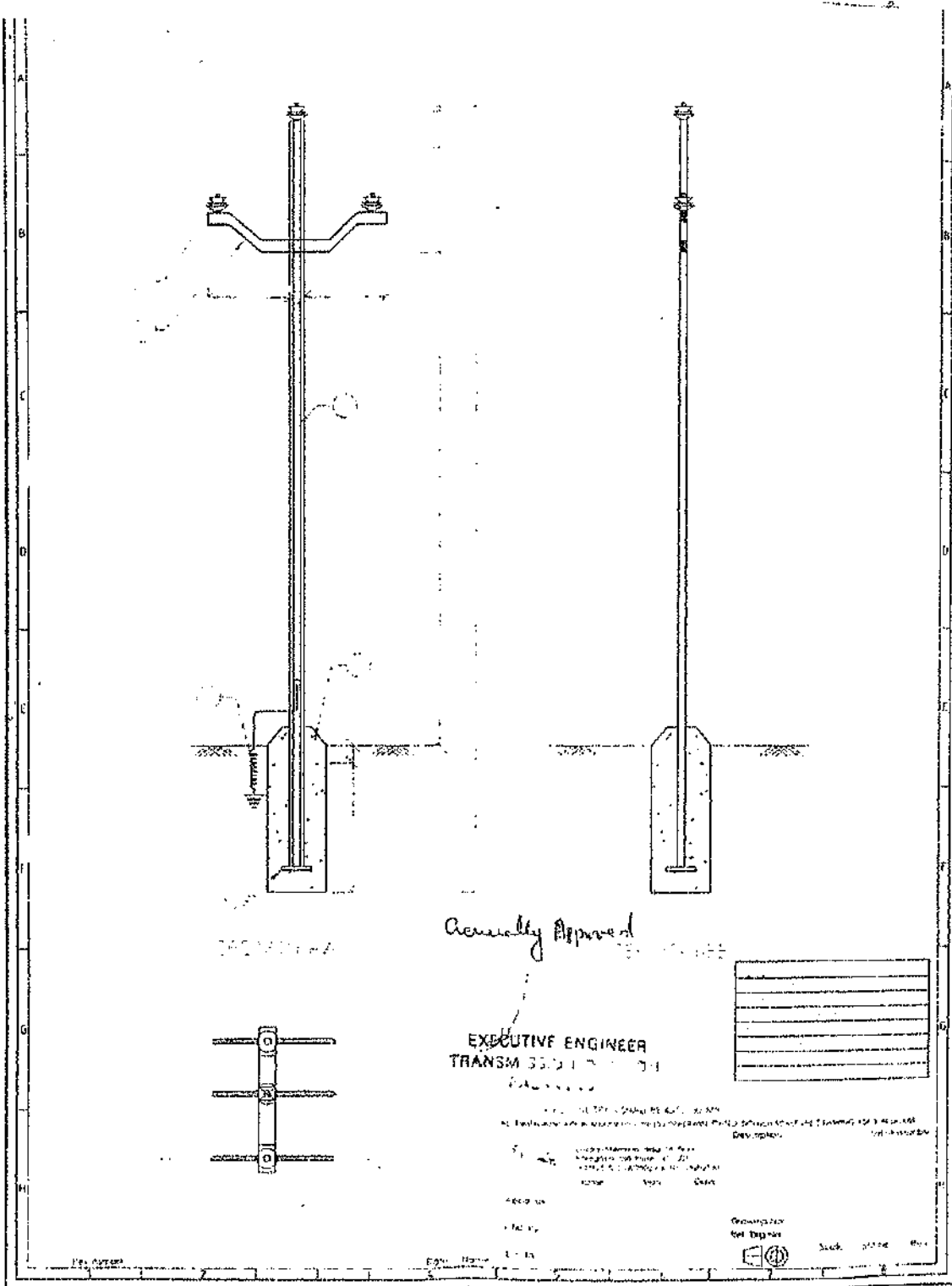

Assembly Approved

EXECUTIVE ENGINEER  
TRANSM...

EQ

Stock Price





SHARATH SANGHAR MOOR LIMITED  
 (A GOVERNMENT OF INDIA ENTERPRISE)  
 OFFICE OF THE DEPUTY GENERAL MANAGER, TELECOM  
 3<sup>rd</sup> FLOOR, C/O BUILDING TALAKKAD-478 001

To  
 The Assistant Executive Engineer, KSEB,  
 Transmission Sub-Division,  
 Mannarkkad

No. T18/HT/1210/07-08/8 dated at Palakkad the 29.11.2007.

Sir,

Sub:- PTCC approval for 33 K.V single circuit from Agali S/S to  
 Suzlon Wind Farm

Ref:- Diagram submitted by you

It has been reported by DE, Mannarkkad vide his letter No.  
 DEU/MGT/PTCC/07-08 dated 29-11-07 that no cable crossing is involved  
 in the above case. As such, energisation approval is hereby accorded for the  
 same.

Thanking you,

Yours faithfully,

*[Signature]*  
 Assistant General Manager ( CP )  
 C/O GMT Palakkad 678 001

Copy to: I. DE, Mannarkkad

FMB / KER-223

DISTRICT : PALAKKAD

VILLAGE : KOTTATHARA

SCALE : 1:1000

SITE : AGALI

SF NO : 524 / P

AREA : 3.00 ACRE

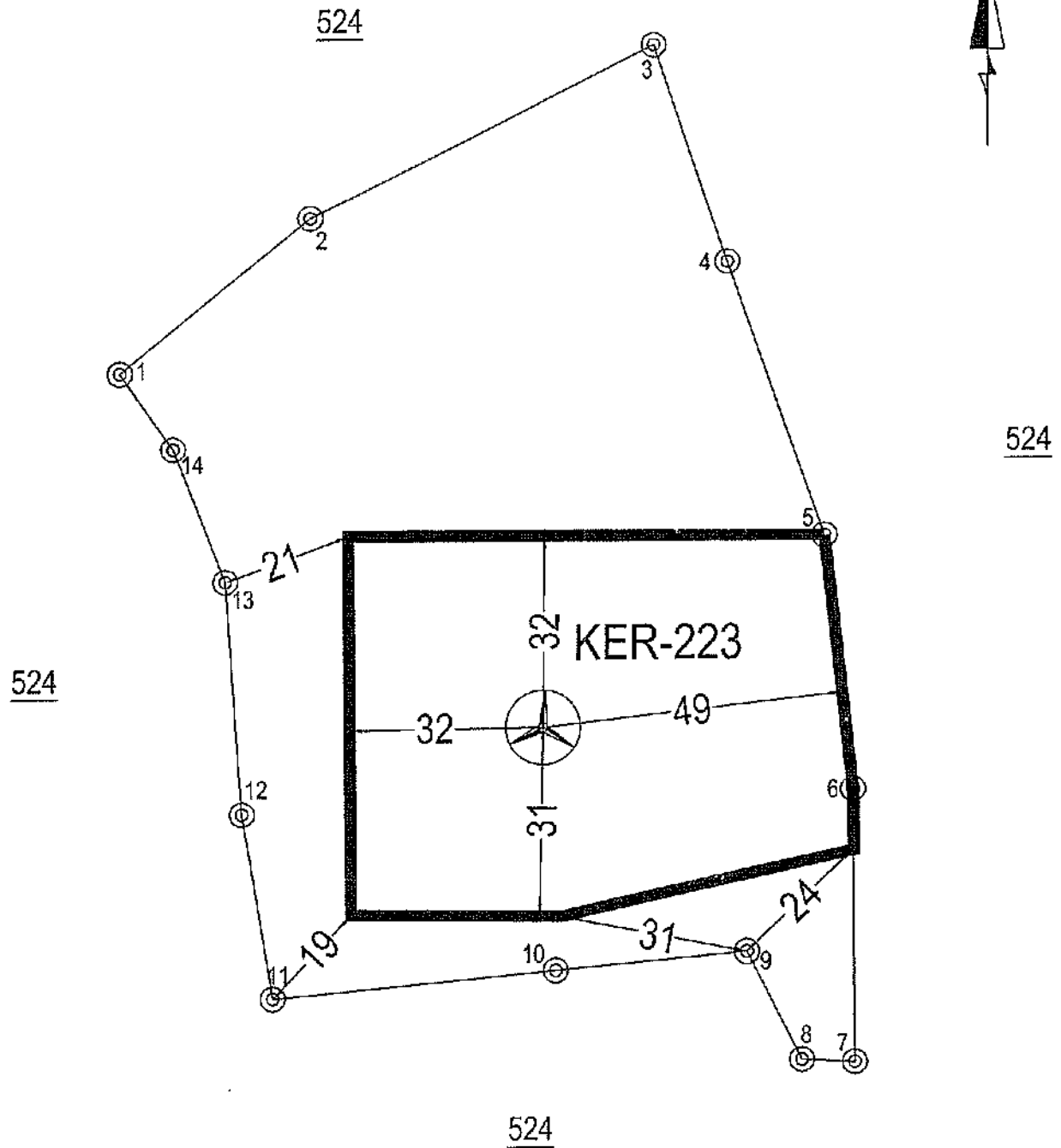

ALL DIMENSIONS ARE IN METER

TOPO SKETCH

TPC/KER-223

69

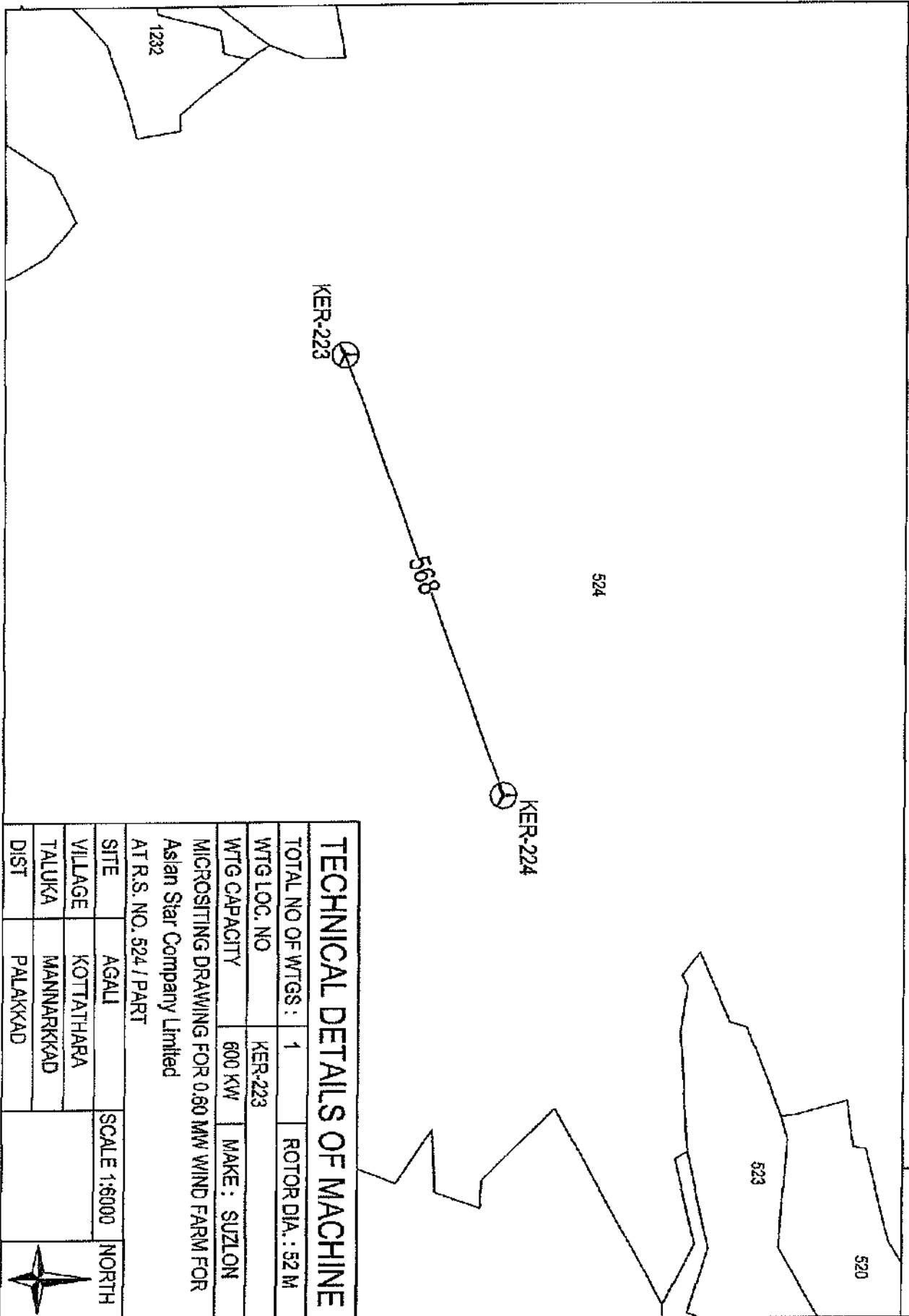

**TECHNICAL DETAILS OF MACHINE**

TOTAL NO OF WTGS :	1	ROTOR DIA. :	52 M
WTG LOC. NO	KER-223		
WTG CAPACITY	800 KW	MAKE :	SUZLON
MICROSITING DRAWING FOR 0.60 MW WIND FARM FOR Aslan Star Company Limited AT R.S. NO. 524 / PART			
SITE	AGALI	SCALE 1:6000	NORTH
VILLAGE	KOTTATHARA		
TALUKA	MANNARKKAD		
DIST	PALAKKAD		





ANNEXURE II

Certified Power Curve  
&  
Single Line Diagram of Electrical System

Enclosed

For ASIAN STAR CO. LTD.,

  
DIRECTOR



Suzlon Energy Ltd,  
Engineering, PUNE

**POWER CURVE DETAILS**  
**S52\_600kW\_50Hz**  
**(With Vortex)**



• **POWER CURVE :-**

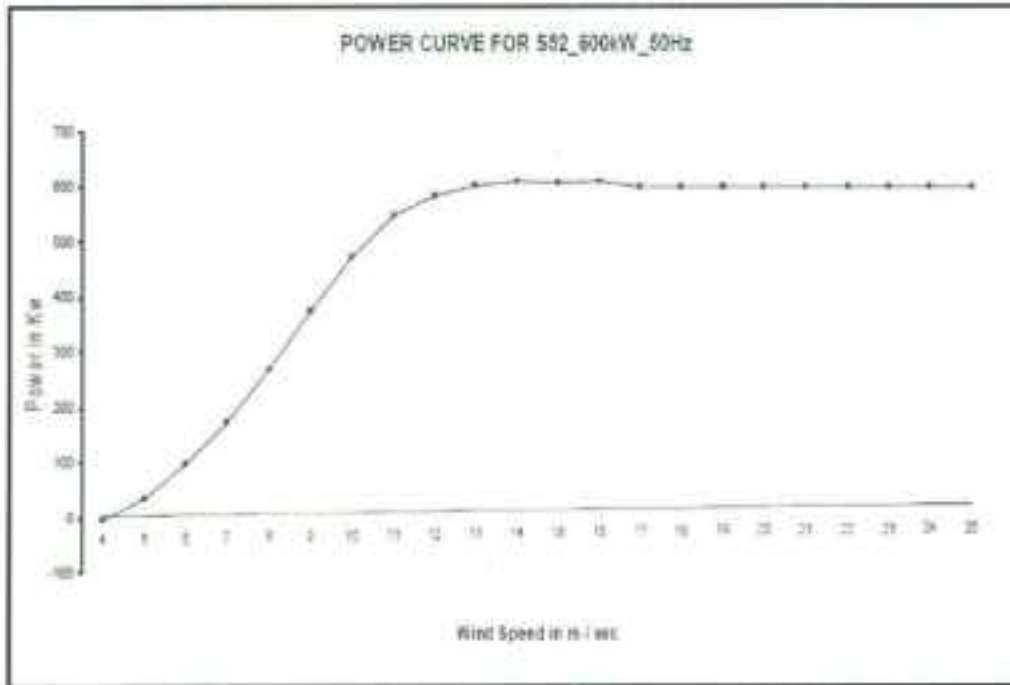

**Document code :-**

Revision	Prepared	Validated by	Verified by	Approved by	File name Power Curve :-
0.0	RRK	NS	FJA	TPK	S52_600kW_50Hz_73m_STV_LT
21-Nov-2008					(For India Market Only)

For ASIAN STAR CO. LTD.,

DIRECTOR

✓

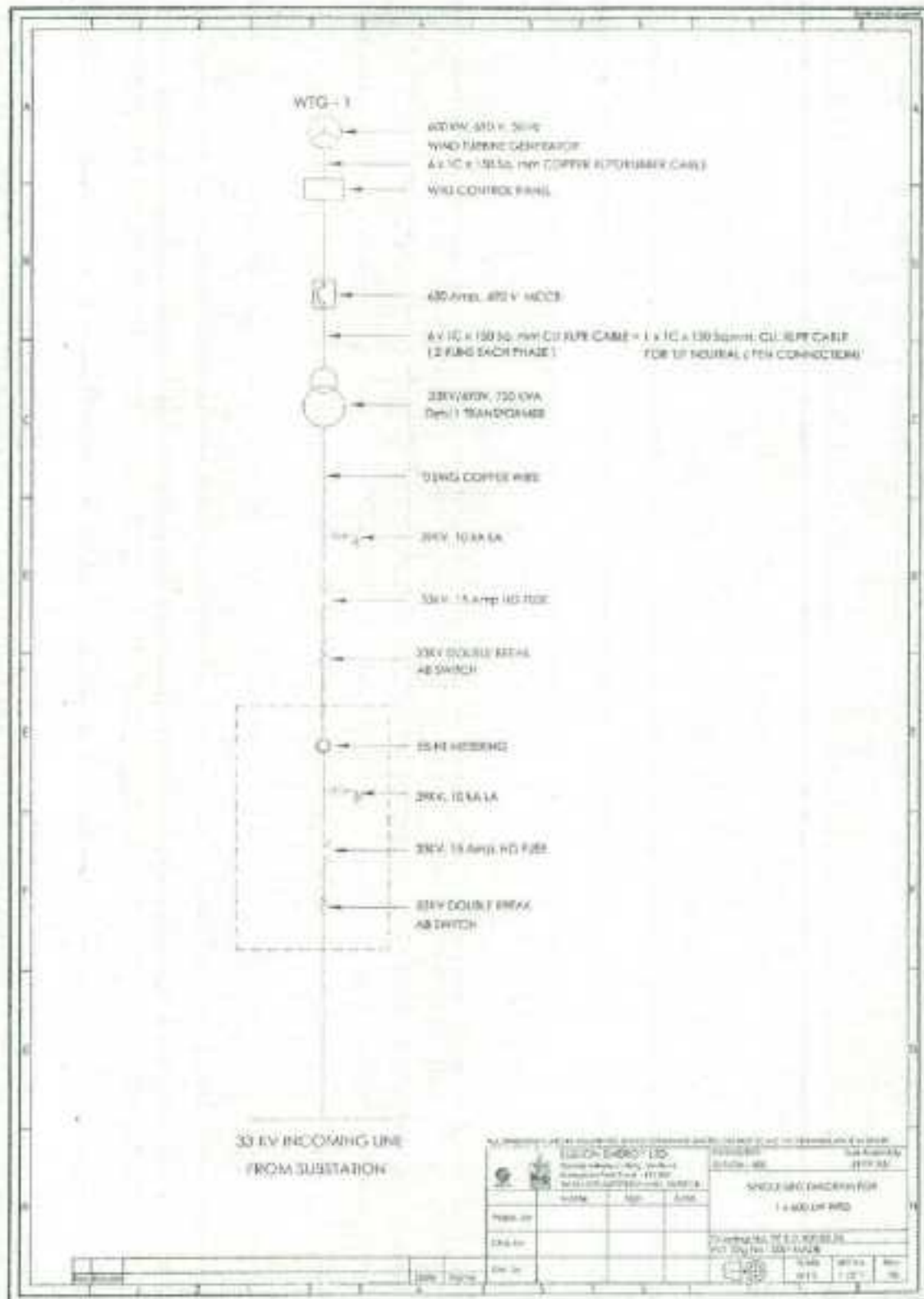

For ASIAN STAR CO. LTD.,

*v. p. m.*  
DIRECTOR

**Annexure III****BILL METER READINGS**

(Reading should be taken on first working day of every month at --- hours)

Name of Generating Company	: M/s. Asian Star Company Limited
Place	: Kottathara
District	: Palakkad
CT. Ratio Available / Connected	: 15/1A
P.T Ratio Available / Connected	: 33KV/110V
Scale Factor (if any)	: NA
Multiplying factor (MF)	: 1
Bill Meter Make/ Number	: LT / SL. No.
Date of Last Meter Reading	: NA

**Meter Readings:****Export Reading****Import Reading****KWH**

Previous Reading

Current Reading

Difference

Difference X Multiplying Factor

**KVARH**

Previous reading

Current reading

Difference

Difference x multiplying factor

**For ASIAN STAR CO. LTD.,****DIRECTOR**



Executive Engineer/Engineer-designate  
Nearest Substation/Generating Station  
KSEB

Authorized Representative  
of Company

Date:

Note:

1. Load Despatch Center, Kalamasssery shall maintain a daily log book of hourly reading of the main meter intimated from the stations over phone/e mail.
2. The Generating Company shall maintain a daily log to record the hourly generation and supply in kWh along with the schedule given by Load despatch center, Kalamasssery.
3. If the meter is changed, the reason/s date, time of meter change and new meter make and number must be recorded by both parties.

For ASIAN STAR CO. LTD.,

DIRECTOR

**Annexure IV****CHECK METER READINGS**

(Reading should be taken on first working day of every month at --- hours)

Name of Generating Company : M/s. Asian Star Company, Limited  
 Place : Kottathara  
 District : Palakkad  
 CT. Ratio Available / Connected : 15/1A  
 P.T Ratio Available / Connected : 33KV/110V  
 Scale Factor (if any) : NA  
 Multiplying factor (MF) : 1  
 Bill Meter Make/ Number : LT / SL. No.  
 Date of Last Meter Reading : NA

**Meter Readings:****Export Reading****Import Reading****KWH**

Previous Reading

Current Reading

Difference

Difference X Multiplying Factor

**KVARH**

Previous reading

Current reading

Difference

Difference x multiplying factor

**For ASIAN STAR CO. LTD.,**
  
**DIRECTOR**

Executive Engineer/Engineer-designate  
Nearest Substation/Generating Station of  
KSEB

Authorised Representative  
of Company

Date:

Note:

- 1 Load Despatch Center, Kalamasssery shall maintain a daily log book of hourly reading of the main meter intimated from the stations over phone/email.
- 2 The Generating Company shall maintain a daily log to record the hourly generation and supply in kWh along with the schedule given by Load despatch center, Kalamasssery.
- 3 If the meter is changed, the reason/s date, time of meter change and new meter make and number must be recorded by both parties.



For ASIAN STAR CO. LTD.,  
  
DIRECTOR







ANNEXURE VI**MONTHLY TRIPPING REPORT**

Name and Address of the Generating Company : M/s. Asian Star Company Limited  
 Installed Generating Capacity : 1 x 600 KW = 0.60 MW  
 Date of First Commissioning (Synchronizing) :  
 Date of Commercial Operation :  
 Date of Last Synchronization :  
 Progressive days (generation) Days

**Tripping on Fault**

S L: N o.	Tripping		Relay Opera ted	Reasons for Tripping			Synchroniz ation		Total Time Lost		Rem arks
	Date	Time		Me- ch	Ele- ctri- cal	Oth- ers	Date	Time	Hr s	Min	
		H r s					M in				

**Planned & Forced Outage**

Sl No	Outage		Reason for Tripping			Synchronize		Total Time lost		Remarks - To whom attributa ble
	Date	Time	Mech	Elect rical	Other	Date	Time	Hr s	Mi n	
		Hrs min					h r s			

**Progressive Days**

**Time lost**  
During

Month  
Year

Since first commissioning

To

1. The Deputy Chief Engineer (Load Depatch Center), KSEB, Kalamassery

For ASIAN STAR CO. LTD.,

*V.P.S.*  
DIRECTOR

✓

